

**RTE Bath/Circulator
with
Microprocessor Controller**

ThermoNESLAB Manual P/N 000260
Rev. 09/20/00

Instruction and Operation Manual



RTE-Series Refrigerated Bath/Circulator

Table of Contents

PREFACE	
	Compliance 2
	Unpacking 2
	Warranty 2
	NES-care 2
	After-sale Support 2
SECTION I	
Safety	
	Warnings 3
SECTION II	
General Information	
	Description 4
	Specifications 4
SECTION III	
Installation	
	Site 5
	Electrical Requirements 5
	Plumbing Requirements 6
	Fluids 8
	Filling Requirements 8
SECTION IV	
Controllers	
	Microprocessor Controller 9
	Start Up 11
	Temperature Adjustment 12
	Alarm/External Functions 13
	Program Functions 14
	Program Control 16
	Error Messages 20
	Miscellaneous 20
	PID Control 21
	Restoring Factory PID Values 21
	MIN Power Mode 21
	Calibration 22
	High Temperature/Low Liquid Level Safety 24
SECTION V	
Maintenance	
	Service Contracts 25
	Condenser 25
	Reservoir Cleaning 25
	Algae 26
SECTION VI	
Troubleshooting	
	Checklist 27
	Service Assistance and Technical Support 28
APPENDIX A	
	RS-232
APPENDIX B	
	International Quick Reference Guides
APPENDIX C	
	Programming Software
WARRANTY	

Preface

Compliance

Products tested and found to be in compliance with the requirements defined in the EMC standards defined by 89/336/EEC as well as Low Voltage Directive (LVD) 73/23/EEC can be identified by the CE label on the rear of the unit. The testing has demonstrated compliance with the following directives:

LVD, 73/23/EEC	Complies with UL 3101-1:93
EMC, 89/336/EEC	EN 55011, Class A Verification EN50082-1:1992 IEC 1000-4-2:1995 IEC 1000-4-3:1994 IEC 1000-4-4:1995

For any additional information refer to the Letter of Compliance that shipped with the unit (Declaration of Conformity).

Unpacking

Retain all cartons and packing material until the unit is operated and found to be in good condition. If the unit shows external or internal damage, or does not operate properly, contact the transportation company and file a damage claim. Under ICC regulations, this is your responsibility.

On units with a remote control box, the box may be packed in a separate carton. Be sure to locate this separate carton; do not dispose of it by mistake.

Warranty

Units have a warranty against defective parts and workmanship for one full year from date of shipment. See back page for more details.

NES-care Extended Warranty Contract

- Extend parts and labor coverage for an additional year.
- Worry-free operation.
- Control service costs.
- Eliminate the need to generate repair orders.
- No unexpected repair costs.

Other contract options are available. Please contact ThermoNESLAB for more information.

After-sale Support

ThermoNESLAB is committed to customer service both during and after the sale. If you have questions concerning the operation of your unit or the information in this manual, contact our Sales Department. If your unit fails to operate properly or if you have questions concerning spare parts or Service Contracts, contact our Service Department.

Before calling, please refer to the serial number label on the rear of the controller to obtain the following information (see Section II, Description for the serial number label location):

- *BOM number* _____

- *Serial number* _____

Section I Safety

Warnings

Make sure you read and understand all instructions and safety precautions listed in this manual before installing or operating your unit. If you have any questions concerning the operation of your unit or the information in this manual, contact our Sales Department.

Performance of installation, operation, or maintenance procedures other than those described in this manual may result in a hazardous situation and may void the manufacturer's warranty.

Transport the unit with care. Sudden jolts or drops can damage the refrigeration lines.

Observe all warning labels.

Never remove warning labels.

Never operate damaged or leaking equipment.

Never operate the unit without bath fluid in the bath.

Never use pure ethylene glycol as a bath fluid. A minimum 80/20 mixture of Ethylene Glycol and tap water is allowed.

For 220 - 240 volt units supplied without a line cord, use a harmonized (HAR) grounded 3-conductor cord, type H 0 5 V V - F , with conductors listed below. A suitable cord end is required for connecting to the equipment (see unit socket) and must terminate with an IEC approved plug for proper connection to power supply.

NON-BOOSTHEATER UNITS	Nominal 1.0 mm² cross section rated 10 Amps Unit Socket: IEC - 320 C13
BOOSTHEATER UNITS	Nominal 1.5 mm² cross section rated 16 Amps Unit Socket: IEC - 320 C19

Always turn off the unit and disconnect the line cord from the power source before performing any service or maintenance procedures, or before moving the unit.

Always empty the bath before moving the unit.

Never operate equipment with damaged line cords.

Refer service and repairs to a qualified technician.

In addition to the safety warnings listed above, warnings are posted throughout the manual. These warnings are designated by an exclamation mark inside an equilateral triangle with text highlighted in bold print. Read and follow these important instructions. Failure to observe these instructions can result in permanent damage to the unit, significant property damage, personal injury or death.

Section II General Information

Description

The RTE-Series Refrigerated Bath/Circulators are designed to provide temperature control for applications requiring a fluid work area or pumping to an external system.

Units consists of a non-CFC air-cooled refrigeration system, circulation pump, seamless stainless steel bath, work area cover, and a temperature controller.

Specifications

	RTE-111	RTE-211	RTE-221
Temperature Range¹	-25°C to +150°C		-23°C to +150°C
Temperature Stability^{2,3,4}	±0.01°C		
Cooling Capacity^{2,5} Watts BTU/H	500 1705		
Pump Capacity	15 lpm at 0' (0 M) 0 lpm at 16' (4.9 M)		
Heater Watts 50 Hz Models	800 1000	800 1000	800/800 boost 1000/800 boost
Bath Work Area (L x W x D) Inches Centimeters	4 3/4 x 8 x 6 12.1 x 20.3 x 15.3	9 1/4 x 10 x 6 23.5 x 25.4 x 15.2	9 1/4 x 10 x 9 23.5 x 25.4 x 22.9
Bath Volume Gallons Liters	1.9 7.0	3.2 12.3	5.4 20.5
Case Dimensions (H x W x D) Inches Centimeters	25 x 10 5/16 x 15 7/8 63.5 x 26.2 x 40.3	25 x 12 3/8 x 18 3/8 63.5 x 31.4 x 46.7	27 7/8 x 12 3/8 x 18 3/8 70.8 x 31.4 x 46.7
Power Requirements⁶	115 V, 60 Hz, 12 Amp 220/240 V, 50 Hz, 7.5 Amp	115 V, 60 Hz, 12 Amp 220/240 V, 50 Hz, 7.5 Amp	115 V, 60 Hz, 16 Amp 220/240 V, 50 Hz, 10 Amp

1. Low end temperature for 50Hz units is -18°C, -23°C and -21°C respectively.
2. Specifications listed for units operating at +20°C bath temperature, +20°C (+70°F) ambient, with tap water as bath fluid.
3. For operation below 0°C, covering the bath work area may improve stability.
4. For some applications, agitation and stability above ambient may be improved by connecting a small length of hose between the pump connections on the rear of the unit.
5. 50 Hz RTE-111 units have a 375 watt cooling capacity.
6. Power Board Transformer Fuse—Analog T 0.5A 250V (Qty 1), Digital T 0.8A 250V (Qty 2)
[T=Time Delay]

Section III Installation

Site

The indentations on the sides of the unit are designed to function as handles. Lift by the handles and locate it on a sturdy workarea. Ambient temperatures should be inside the range of +50°F to +80°F (+10°C to +27°C).



Never place the unit in a location where excessive heat, moisture, or corrosive materials are present.

The unit has an air-cooled refrigeration system. Air is drawn through the front panel and discharged through the rear panel. The unit must be positioned so the air intake and discharge are not impeded. A minimum clearance of 12 inches (30 centimeters) at the front and rear of the unit is necessary for adequate ventilation. Inadequate ventilation will reduce cooling capacity and, in extreme cases, can cause compressor failure.

Excessively dusty areas should be avoided and a periodic cleaning schedule should be instituted (see Section VI, Cleaning).

The unit will retain its full rated capacity in ambient temperatures up to approximately +75°F (+24°C). Reduce the cooling capacity 1% for every 1°F above +75°F, to a maximum ambient temperature of +95°F. In terms of °C, reduce the cooling capacity 1% for every 0.5°C above +24°C, to a maximum ambient temperature of +35°C.

Electrical Requirements



Line voltage may be easily accessible inside the pump/control box. Always unplug the unit prior to removing the pump/control box cover.

Refer to the serial number label on the rear of the unit to identify the specific electrical requirements of your unit.

Ensure the voltage of the power source meets the specified voltage, ±10%.

The unit construction provides extra protection against the risk of electric shock by grounding appropriate metal parts. The extra protection may not function unless the power cord is connected to a properly grounded outlet. It is the user's responsibility to assure a proper ground connection is provided.



For 220 - 240 volt units supplied without a line cord, use a harmonized (HAR) grounded 3-conductor cord, type H 0 5 V V - F , with conductors listed below. A suitable cord end is required for connecting to the equipment (see unit socket) and must terminate with an IEC approved plug for proper connection to power supply.

BOOSTHEATER UNITS	Nominal 1.5 mm² cross section rated 16 Amps Unit Socket: IEC - 320 C19
NON-BOOSTHEATER UNITS	Nominal 1.0 mm² cross section rated 10 Amps Unit Socket: IEC - 320 C13

Plumbing Requirements



Ensure the unit is off before connecting tubing to the unit.

To prevent damage to the plumbing lines, always support the 3/4" fittings while installing/removing the pumping caps and lines.

Hose Connections

The pump connections are located at the rear of the pump box and are labelled PUMP INLET and PUMP OUTLET. These connections are bent upward so the recirculating fluid will drain back into the reservoir when the hoses are disconnected. Both connections are capped with stainless steel serrated plugs.

The pump lines have 1/4 inch male pipe threads for mating with standard plumbing fittings. For your convenience stainless steel adapters, 1/4 inch female pipe thread to 3/8 inch O.D. serrated fitting, are provided. (To assure proper fit, they should be installed using Teflon® tape around the threads.)

Flexible tubing, if used, should be of heavy wall or reinforced construction. Make sure all tubing connections are securely clamped. Avoid running tubing near radiators, hot water pipes, etc. If substantial lengths of tubing are necessary, insulation may be required to prevent loss of cooling capacity.

Tubing and insulation are available from ThermoNESLAB. Contact our Sales Department for more information (see Preface, After-sale Support).

It is important to keep the distance between the unit and the external system as short as possible, and to use the largest diameter tubing practical. Tubing should be straight and without bends. If diameter reductions must be made, make them at the inlet and outlet of the external system, not at the unit.

If substantial lengths of cooling lines are required, they should be pre-filled with bath fluid before connecting them to the unit. This will ensure that an adequate amount of fluid will be in the bath once it is in operation.

Pumping

The pump is designed to deliver a flow of 15 liters per minute (4 gallons per minute) at 0 feet head. To prevent external circulation, the PUMP INLET and PUMP OUTLET lines on the rear of the unit are capped. The caps must be removed when external circulation is required.

To properly secure external hose connections to the unit, wrap Teflon® tape around the pipe line threads before installation. Once the hose connections are made, the hoses must be properly plumbed to an external system. *It is important the bath is not in operation until all plumbing is complete.*

If the bath is not used for external circulation, make sure the stainless steel caps are in place prior to operating the bath.

Circulating to an open container

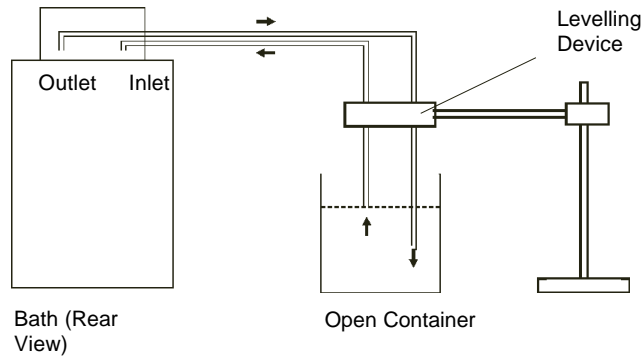

A stainless steel leveling device is available to aid circulation to an open vessel. Contact our Sales Department for more information (see Preface, After-sale Support).

Support the leveling device over the open container with a ringstand. Stagger the tubes in the leveling device so one tube is submerged in the vessel fluid, and the other tube is level with the fluid surface. Connect the deeper tube to the PUMP OUTLET and the shorter tube to the PUMP INLET.

Adjust the flow rate using the accessory flow control valve connected to the PUMP OUTLET, or by partially restricting the outlet tubing. When properly adjusted, the pump inlet will draw an occasional air bubble to prevent over flow, and the pump outlet will force fluid through the submerged tube to prevent aeration of the vessel.

To avoid siphoning the bath work area when the unit is shut off, lift the leveling device out of the vessel and above the level of the unit.

Circulating through two closed loops

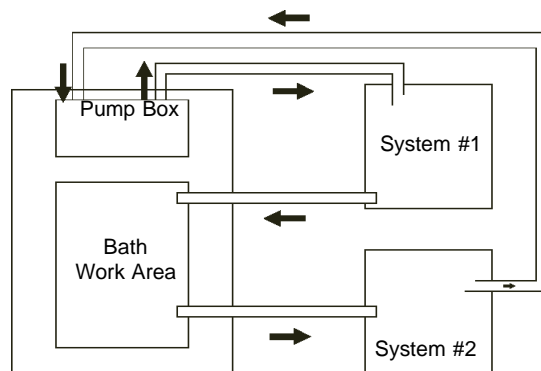

Bath (Top View)

The pump can be used to circulate through two closed loop systems. Connect the shortest practical length of flexible tubing from the PUMP OUTLET to the inlet of external system #1. Connect the outlet of system #1 directly into the bath work area. Connect tubing from the bath work area to the inlet of system #2. Connect the outlet of system #2 to the PUMP INLET.

Drain



Ensure the temperature of the bath fluid is safe before draining the unit.

The unit is equipped with a drain located at the back of the unit at the base of the bath. The drain has ¼ inch male pipe threads and is capped with a stainless steel plug. To drain the reservoir simply remove the cap.

To assure proper fit when replacing the cap, be sure to line the threads with Teflon tape.

Fluids



Never use flammable or corrosive fluids with this unit.

The selected fluid must have a viscosity of 50 centistokes or less at the lowest operating temperature.

Filtered tap water is the recommended fluid for operation from +8°C to +80°C.

For operation from +8°C to -30°C, a 50/50 mixture, by volume, of filtered tap water and laboratory grade ethylene glycol is suggested.

Above +80°C and below -30°C, the user is responsible for fluids used.



Never use pure ethylene glycol as a bath fluid. A minimum 80/20 mixture of Ethylene Glycol and tap water is allowed.

Filling Requirements

The bath work area has a high and low level marker to guide filling. The markers are 1 inch horizontal slits located in the center of the stainless steel baffle separating the work area and the pump assembly. The correct fluid level falls between these two markers. The heating and cooling coils will be exposed and may become damaged if the correct fluid level is not provided.

When pumping to an external system, keep extra fluid on hand to maintain the proper level in both the circulating lines and the external system.



Never run the unit when the work area is empty. Avoid overfilling. Overfilling the bath may damage the insulation and affects stability.

Section IV Microprocessor Controllers

Microprocessor Controller

Description

The microprocessor controller is designed as a separate component from the unit. The controller can be mounted directly on the pump box, or remotely from the bath. The controller provides proportional with integral and derivative (PID) control.

The controller has two sections. The upper section contains the LED indicators and the Main display which provide feedback to you about the controller and bath. The ten individual LED indicators provide output on selected parameters while the Main display will provide information on various unit conditions. The lower section contains the keypad you use to input data to the controller.

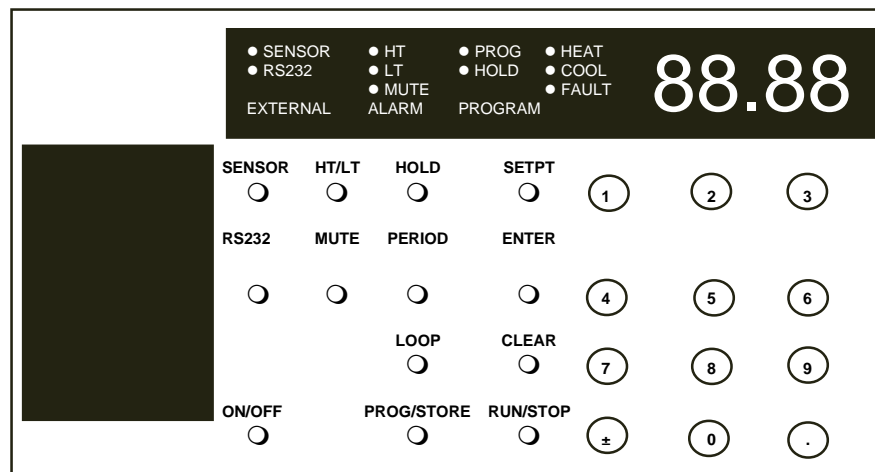

Microprocessor Temperature Controller (Front View)

Controller Mounting

The controller can be removed from the bath and placed in a remote location. Extension cables are available from ThermoNESLAB. Contact our Sales Department for more information.

Controller Connection

Microprocessor controllers are supplied with a cable needed to connect the controller to the pump box. Connect the cable to the 25-pin male connector on the control box and the female connector on the pump box. Once the connection is made, the unit is ready for operation.

NOTE: The MAIN POWER should be OFF before connecting/disconnecting cables from the control box.

LED Indicators

The following table explains the controller LED indicators. The LEDs can be on, off or flashing.

LED	STATUS	INDICATION
SENSOR	OFF	All controller functions are operating from the unit's internal probe.
	ON	All controller functions are operating from remote sensor input.
	FLASHING	The Main display indicates the remote sensor temperature. The controller, however, still uses the internal probe to control the bath temperature.
RS232	OFF	Communication port disabled.
	ON	Communication port enabled.
	FLASHING	Awaiting next key press
LT	OFF	No alarm.
	ON	Main display indicates low limit setpoint.
	FLASHING	Low limit alarm condition.
HT	OFF	No alarm.
	ON	Main display indicates high limit setpoint.
	FLASHING	High limit alarm condition.
HOLD	OFF	Programming hold feature disabled.
	ON	Programming hold feature enabled.
PROG	OFF	No program running.
	ON	The program is suspended ¹ .
	FLASHING	The program is running.
COOL	OFF	Refrigeration is off ² .
	ON	Refrigeration is on.
HEAT	OFF	The heater is off.
	ON	The heater is on.
	FLASHING	The heater duty cycle.
MUTE	OFF	The alarm is enabled.
	ON	The alarm horn is disabled.
	FLASHING	The alarm horn has been disabled for any current condition. The alarm horn will automatically reset when the condition is cleared.
FAULT	OFF	No fault condition.
	ON	The high temperature/low level safety has activated.

1. The bath fluid will maintain the setpoint achieved at the time the program is suspended, except when the bath is in a rapid cool segment. No operator inputs are available to the controller while in a suspended condition.

2. Below 40°C the refrigeration is on unless the setpoint is more than 2°C above the bath temperature. This allows rapid heat up. Above 40°C refrigeration is off unless the setpoint is more than 2°C below the bath temperature. This allows rapid cool down.

Start Up

Before starting the unit, check all electrical and plumbing connections and make sure the work area has been properly filled with bath fluid.

NOTE: The fluid level should be between the two lateral slots at the rear of the reservoir.

To power the controller on 115V units, place the MAIN POWER switch on the side of the unit to the ON position. This only supplies power to the controller. *The unit itself is not operating.* The Main display on the controller will display OFF.

220V units have a circuit breaker instead of a switch. The circuit breaker is labeled **I** (power on) and **O** (power off). Ensure the circuit breaker is in the **I** position.

Press the keypad ON/OFF button on the controller. The pump will start and the Main display will indicate the temperature of the fluid in the bath. The controller will respond to the current setpoint.

Pressing the keypad ON/OFF button again will disable control of the bath and shut down the pump. The Main display indicates OFF. (When the controller is in the RS232 mode of operation, see page 13, the ON/OFF button is deactivated. Control of the bath can only be disabled via an RS232 input.)

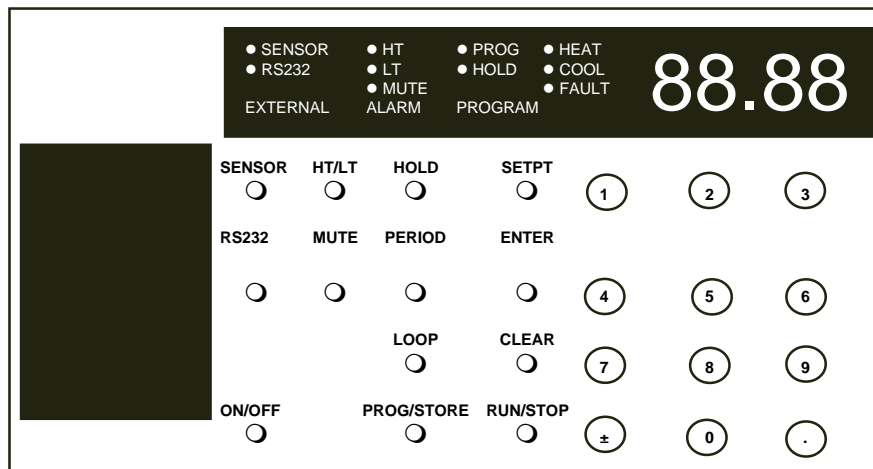

Microprocessor Temperature Controller (Front View)

Temperature Adjustment

To display the temperature setpoint, press SETPT. The Main display will flash the current setpoint. Press ENTER to return the display to the bath's fluid temperature. To adjust the setpoint press SETPT and then press CLEAR, the display will go blank. Use the keypad to input the desired value. If the value is correct press ENTER. If the value is incorrect press CLEAR, the display will go blank. Use the keypad to correct the value and press ENTER.

Low and High Temperature Limits

To display the temperature limits, press HT/LT. Either the HT or LT LED will illuminate and the Main display will flash the corresponding temperature limit. Press ENTER and then press HT/LT again to observe the other temperature limit. The corresponding LED on the controller will illuminate. Should either limit be exceeded an alarm will sound (if not muted) and the corresponding LED will flash.

To adjust either limit, press HT/LT and then press CLEAR, the display will go blank. Use the keypad to input the desired value. If the value is correct press ENTER. If the value is incorrect press CLEAR, the display will go blank. Use the keypad to correct the value and press ENTER. Use the LT or HT LED indicators to verify which temperature limit you are changing.

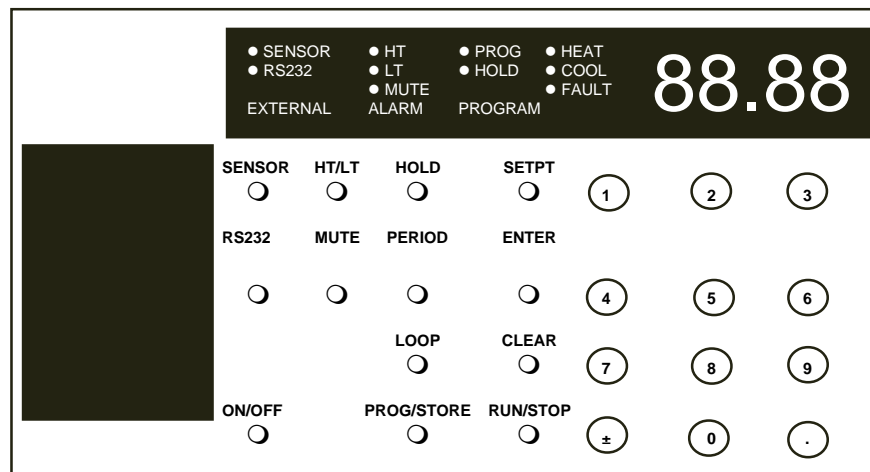

Microprocessor Temperature Controller (Front View)

Alarm/External Functions

Mute Alarm

The alarm audio may be permanently silenced by pressing MUTE, and then immediately (within one second) pressing HOLD. The MUTE LED will now stay lit. To restore the audio, press MUTE and then immediately (within one second) press CLEAR. The MUTE LED will extinguish.

If desired, you may mute the audible portion of an alarm for an existing condition. Press MUTE on the temperature controller. The MUTE LED flashes to indicate a muted alarm horn. The MUTE button acts as a toggle switch to activate/deactivate the alarm horn. The appropriate HT or LT LED will continue to flash during the alarm condition. If the alarm is muted for an existing condition it will automatically reset once the temperature limit problem is corrected. The alarm will resound if a limit is exceeded another time unless MUTE is pressed again.

Sensor

The controller has the capability to enable and/or monitor a remote bath's temperature sensor. (Remote sensor probes of various sizes are available from ThermoNESLAB. Contact our Sales Department for more information.) Pressing SENSOR, when a remote sensor is properly connected to the controller's 9-pin SENSOR connector, will display the remote sensor's temperature on the Main display. The SENSOR LED will flash. *The controller and alarm, however, will continue to respond to the signals from the unit's internal probe.*

To completely transfer all display, control and alarm functions to the remote sensor, press SENSOR and then press ENTER. The SENSOR LED will stay lit. The controller will not respond to the signal from the unit's internal probe.

To disable the remote sensor press SENSOR and then press CLEAR. The SENSOR LED will extinguish. All display and alarm functions will again respond to the signal from the unit's internal probe.

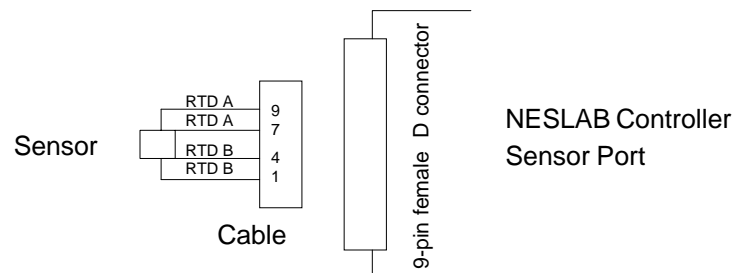

RS232

The unit can be controlled through your computer's serial port by using a standard 9-pin RS232 connection on the rear of the temperature controller. For complete information see Appendix A.

Program Functions

Programming

The microprocessor controller can store up to 8 temperature programs, each one having up to 15 program steps (16 setpoints). You can select, enter or run one program at a time. The procedure for selecting a program is discussed in Program Control on page 16. The programs can cover the unit's full temperature operating range in 0.01°C increments. Step times can vary from 0.1 to 6,500 minutes in 0.1 minute increments. Each program can be set up to run as many as 9999 repetitions (LOOPS).

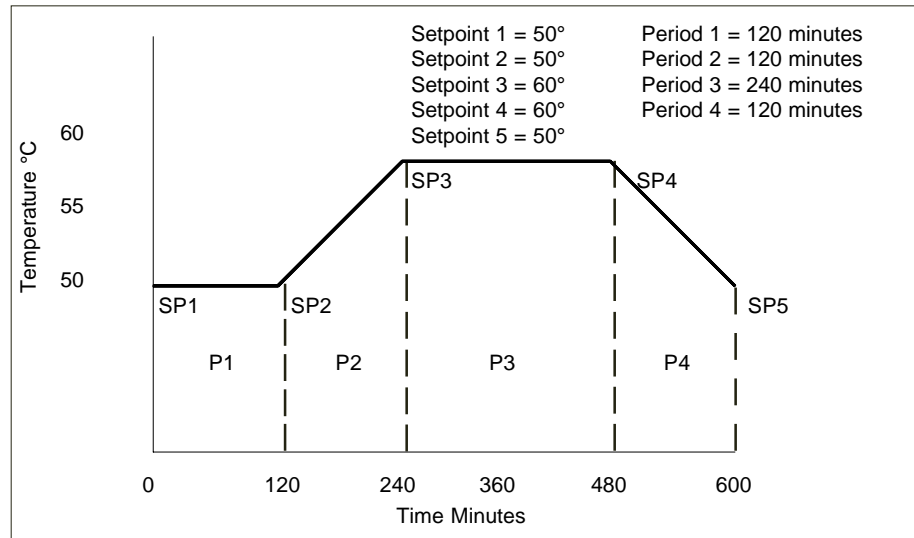

Typical Program

The controller can store all programs in its nonvolatile memory, see Program Control on page 16.

Programming begins with program definition. Define your program as a series of setpoints with a known period of time interval between each. Each interval is one step of the program. Pay careful attention to the first part of your program. What conditions must exist at the beginning of your process? For example, at the starting setpoint you may wish to program an initial period of constant temperature to allow for thermal stabilization.

When a program is started, it begins immediately at the initial program setpoint.

Consider the unit's limitations when designing programs. Temperature or time parameters which exceed the performance capabilities of the bath will result in unsatisfactory operation. It is possible to create a program calling for very rapid changes in temperature. Although the equipment may not be capable of producing such changes, it may be practical to program such steps as a way to cause the fastest *possible* temperature change.

NOTE: Below 40°C the refrigeration is on unless the setpoint is more than 2°C above the bath temperature. This allows rapid heat up. Above 40°C refrigeration is off unless the setpoint is more than 2°C below the bath temperature. This allows rapid cool down.

Loops

This option allows for automatic repetition(s) of a program. For example, set the number of loops to three. Once the program reaches the last setpoint, it will loop back to the first setpoint and run the program again. In this instance the program will loop back three times. The entire program will run a total of four times. The maximum number of loops is 9999.

Hold

This option determines what will happen at the end of a program. In the hold mode of operation the setpoint will remain at the final temperature when the program is completed. Without hold the setpoint will return to the starting setpoint when the program is completed. The setpoint may change abruptly, but the fluid temperature will respond as quickly as the system's heating and cooling capacity allows.

The procedures for placing the controller in the hold mode is discussed in Program Control on page 17.

Current Values

While a program is running, the program selected, current period, current setpoint, time remaining for the current step, or the current loop, may be viewed on the Main display. Momentarily depress the appropriate key listed below to view the desired parameter. After several seconds, the Main display will again indicate the temperature of the bath fluid.

SETPT -----	View Current Setpoint
LOOP -----	View Current Loop
PERIOD -----	Time Remaining in Current Period
PERIODPERIOD -----	Current Period Number
+/- followed immediately by PROG/STORE ----- Selected Program Number	

Assured Soak

This option is used when you need to ensure the bath temperature will reach the next setpoint (regardless of time) before moving onto the next period.

This option is controlled by a DIP switch on the rear of the controller. Turn DIP switch number seven (7) to the ON position to enable this feature.

Period Adjust

This option is used to skip the current period of a running program. See Table 13 on page 19 for the appropriate procedure. **NOTE:** If Assured Soak is activated, the bath *must* reach that setpoint before the program will continue.

Rapid Cool

This option is used to enable maximum cooling operation. This option is available with or without a program running. **NOTE:** The unit is normally in a maximum cooling mode when the bath temperature is below 28°C.

When not running a program, if you enter a setpoint greater than 2°C colder than the current bath temperature, maximum cooling will be enabled until the setpoint is reached.

For programming, determine which program period(s) will require maximum cooling. Then instead of entering a time for those periods, press the " - + " button on the keypad. The Main display will indicate FASt verifying a rapid cool down period has been entered. When the appropriate program period is executed, maximum cooling will be enabled until the setpoint is reached.

Program Control

The following tables show how to use the keypad and Main display to program the controller.

Use Table 1 to select one of the eight programs to be the current program for either entering or running.

TABLE 1		
Keypad input	Main Display	Comments
+/-	Current bath temperature	
-PROG/STORE ¹	Pro followed by the program number	Enter desired program number.
-ENTER	Current bath temperature	

1. PROG/STORE must be depressed immediately (within one second) after +/-.

Once Table 1 is complete, use Table 2 for entering and storing a two-setpoint program. You would follow this procedure for programming any number of setpoints (up to the 16 setpoint maximum).

NOTE: The number of setpoints must be one greater than the number of periods or you will get an error message.

TABLE 2		
Keypad input	Main Display	Comments
-PROG/STORE	-----	If YES appears you should clear the current program (see Table 10).
-SETPT	SP-1	Input setpoint.
-ENTER	Desired setpoint	
-PERIOD	P-1	Input time in minutes.
-ENTER	Desired time	
-SETPT	SP-2	Input setpoint.
-ENTER	Desired setpoint	
-LOOPS	LOOPS	Input number of loops
-ENTER	Desired number of loops	
-PROG/STORE	FILE?	
-ENTER	Current bath temperature	

Use Table 3 to abort programming at any time.

TABLE 3		
Keypad input	Main Display	Comments
-ENTER	-----	
-PROG/STORE	FILE?	
-CLEAR	Current bath temperature	

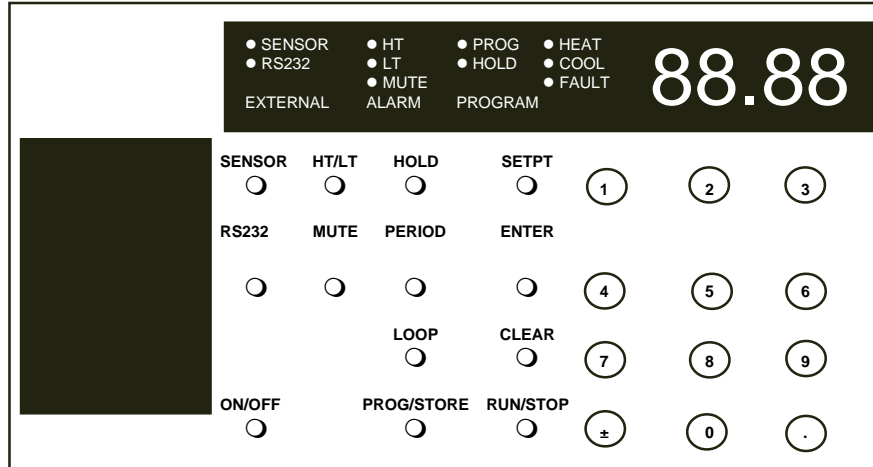

Microprocessor Temperature Controller (Front View)

Use Table 4 to scroll through a two-setpoint stored program. You would use this procedure for scrolling any number of setpoints (up to the 16 setpoint maximum).

TABLE 4		
Keypad input	Main Display	Comments
-PROG/STORE	YES	
-ENTER	SP-1 followed by actual value	
-ENTER	SP-2 followed by actual value	
-ENTER	P-1 followed by actual value	
-ENTER	LOOPS followed by actual value	
-ENTER	Current bath temperature	

Use Table 5 to abort scrolling through a program at any time.

TABLE 5		
Keypad input	Main Display	Comments
-PROG/STORE	FILE?	
-ENTER	Current bath temperature	

Once Tables 1 and 2 are complete, use Table 6 to run a stored program.

TABLE 6		
Keypad input	Main Display	Comments
-RUN/STOP	Current bath temperature	PROG LED will flash.

Use Table 7 to stop a running program.

TABLE 7		
Keypad input	Main Display	Comments
-RUN/STOP	Current bath temperature	PROG LED will stay on steady.
-CLEAR	Current bath temperature	PROG LED extinguishes.

Use Table 8 to temporarily suspend a running program.

TABLE 8		
Keypad input	Main Display	Comments
-RUN/STOP	Current bath temperature	PROG LED stays on steady.

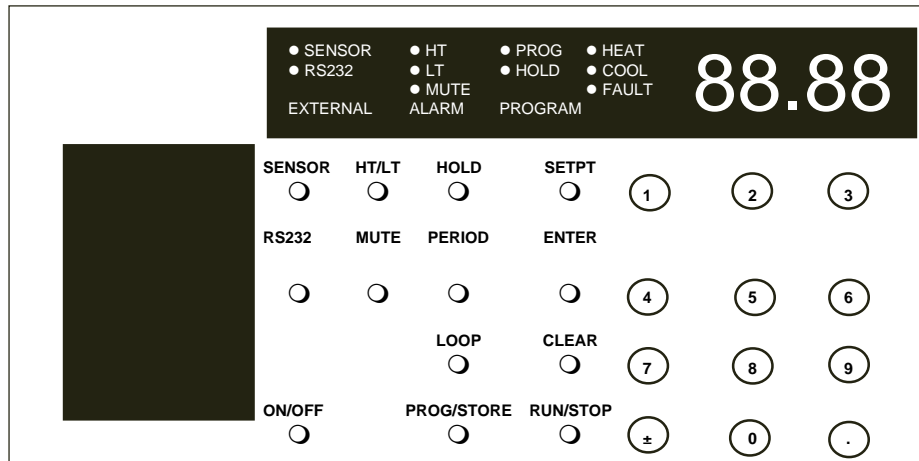

Microprocessor Temperature Controller (Front View)

Use Table 9 to resume a suspended program.

TABLE 9		
Keypad input	Main Display	Comments
-RUN/STOP	Current bath temperature	PROG LED flashes.

Use Table 10 to clear a stored program.

TABLE 10		
Keypad input	Main Display	Comments
-PROG/STORE	YES	
-PROG/STORE	FILE?	
-CLEAR	Current bath temperature	

Use Table 11 to add HOLD operation. (Hold must be established before running a program. The hold function is not part of the stored program.)

TABLE 11		
Keypad input	Main Display	Comments
-PROG/STORE	YES	
-HOLD	YES	HOLD LED stays on steady.
-PROG/STORE	FILE?	
-ENTER	Current bath temperature	

Use Table 12 to clear hold operation.

TABLE 12		
Keypad input	Main Display	Comments
-PROG/STORE	YES	
-HOLD	YES	HOLD LED extinguishes.
-PROG/STORE	FILE?	
-ENTER	Current bath temperature	

Use Table 13 to force a running program to skip ahead to the next period.

TABLE 13		
Keypad input	Main Display	Comments
+/-	Current bath temperature	
-PERIOD ¹	P-Adj	(Period adjust)

1. PERIOD must be depressed immediately (within one second) after +/-.

Error Messages

The Main LED will indicate an error message for eight different conditions.

Error1 - Program incomplete or illogical. Re-enter the program.

Error2 - Period entered exceeds 6,500 minutes. Reenter a period.

Error3 - Entered value exceeds allowable limits. Reenter proper value.

Error4 - Loops entered greater than 9,999. Reenter loops

Error5 - Attempted to run a program without a program in memory. Build a program.

Error6 - No period or 0 entered for a program period. Enter a period.

Error7 - With alarm - SENSOR depressed without a sensor properly connected to controller. Properly connect a sensor. (If sensor is properly connected the sensor may have failed.)
Without alarm - Internal probe failure, unit will shut off.

Error8 - Internal nonvolatile memory has failed. Press ENTER for the controller to reinitialize nonvolatile memory to factory preset parameters. **NOTE:** This will erase any program and setpoints in nonvolatile memory. The unit will have to be recalibrated.

Miscellaneous

Additional Parameters

Two parameters can also be set while the controller is deactivated (Main display shows OFF). You can adjust the light intensity of the Main display and set the controller pushbuttons to "beep" or not when depressed.

To adjust the Main display intensity first press the "±" key on the controller keyboard. Repeatedly depress the "1" key to decrease intensity or the "3" key to increase. Each press changes the intensity an incremental amount. Once the desired intensity is displayed press ENTER.

To silence the "beep" first press the "." key. Press "0" to turn the beep off or press "1" to turn it on. Next, press ENTER.

DIP Switches

Three DIP switches on the rear of the controller are operational. Switch #1 controls the temperature scale. OFF (up position) displays the temperature in °C, ON (down position) displays the temperature in °F.

Switch #6 sets the display update rate the controller uses to display temperature. This will determine how sensitive the display will be to temperature fluctuations. OFF (up position) sets a fast rate, ON (down position) sets a slow rate. (OFF causes more fluctuations than ON.)

Switch #7 controls the assured soak option for programs. ON (down position) enables assured soak.

PID Control

PID controllers are best suited for systems that may experience changing heat loads. Proportional control is combined with Integral and Derivative adjustments which allow the controller to automatically compensate for any changes from the setpoint. You may have to experiment with the PID settings to find out which are most suitable to your application.

To change or view any of the PID settings the controller must be operating.

To change or view the proportional band, press "1" and immediately, within one second, press ENTER. The "percent of span" value will flash on the Main display. Press ENTER to accept the value. To change the value press CLEAR and then enter the desired value. Press ENTER to exit this mode.

To change or view the Integral, press "2" and immediately, within one second, press ENTER. The "repeats per minute" value will flash on the Main display. Press ENTER to accept the value. To change the value press CLEAR and then enter the desired value. Press ENTER to exit this mode.

To change or view the Derivative, press "3" and immediately, within one second, press ENTER. The "minutes" value will flash on the screen. Press ENTER to accept the value. To change the value press CLEAR and then enter the desired value. Press ENTER to exit this mode.

Restoring Factory Preset Values

To restore the factory preset values hold the "0" button on the keypad and turn the Main Power switch on the side of the unit to the ON position. Release the "0" button and the Main display will indicate OFF. The following preset values will be installed:

P = 0.6%
I = 0.25 repeats per minute
D = 0.05 minutes

In addition, the following values will be preset

BAUD Rate = 9600
Stop bits = 1
Data Bits = 8
Parity = none

MIN Power Mode

If desired, you can trade off bath cooling speed for increased temperature stability. You do this by placing the refrigeration system in a minimum power mode. **NOTE:** Above 50°C (122°F), better stability is achieved with the bath cover removed.

To place the unit in this mode press "5" followed immediately (within one second) by ENTER. The decimal point to the right of the Main display's °C or °F will flash. To exit and resume normal operation, press "5" followed immediately (within one second) by CLEAR.

Calibration

The microprocessor controller has three different modes of calibration: Self-Cal, Two-point, and One-point. The controller is shipped from the factory with a Two-point calibration so no additional controller calibration may be required. Both the internal probe and the remote sensor input must be independently calibrated. Different calibration modes for each probe can be used if desired. The remote sensor input has been Self-Calibrated at the factory.

Self-Cal is used to initialize the analog-to-digital (A/D) converter input channel before performing the other types of calibrations. This mode removes all previous calibrations and brings the measurement error to less than 2°C. If this is the required accuracy, then no additional calibration is needed.

Two-point calibration is used to negate A/D and probe errors over the full span of the controller. This type of calibration is performed when high accuracy is desired.

One-point calibration (offset) is used to make the controller very accurate at one specific operating temperature.

One-point Calibration can be performed after a Two-point calibration as many times as desired. Each One-point calibration adds a different offset to the original Two-point calibration data (if one was already performed).

Calibration Procedures

Note: The controller should be powered at least 15 minutes before calibration to assure the electronic circuits are at operating temperature. To perform One and Two-point calibrations on the remote sensor input the unit must be in the remote sensor mode. Messages will end with CAL 1 for internal probe calibrations and CAL 2 for remote sensor calibrations.

Self-Cal: The controller must be deactivated (displaying OFF) to access this mode. Press SETPT followed by ENTER to Self-Cal the internal probe input. The message "S-CAL 1" will be followed by "done". To Self-CAL the sensor input press SENSOR followed by ENTER. The message "S-CAL 2" followed by "done" will be displayed.

Two-point: For high accuracy measurements the controller input can be calibrated at two points. These two points (one high, one low) should be as far apart as practical for good performance.



Do not pick points that are outside the safe operating limits of the fluid in your application. For example with a water bath, 5°C and 90°C would be typical calibration points.

Before a Two-point cal, Self-cal must be performed on the desired sensor input.

With the controller on and measuring from the internal or remote probe, depending on which sensor is being calibrated, set the controller setpoint to the desired high cal temperature. When the bath reaches the setpoint and stabilizes, measure the actual bath temperature with an external calibrated thermometer. Press in quick succession “2” “.” “ENTER”. The message H-CAL # will appear followed by the flashing setpoint. Now enter in the actual bath temperature as measured by the calibrated thermometer and press ENTER. The Main display will indicate the temperature of the bath fluid (the calibrated temperature will not appear until the next step is complete).

Next set the controller setpoint to the desired low cal temperature. When the bath reaches this setpoint and stabilizes, measure the actual bath temperature with an external calibrated thermometer. Press in quick succession “2” “.” “ENTER”. The message L-CAL # will appear followed by the flashing setpoint. Now enter in the actual bath temperature as measured by the calibrated thermometer and press ENTER. The Main display will now indicate the calibrated temperature of the fluid in the bath.

One-point: Before a One-point cal, Self-cal or Two-point cal must be performed on the desired sensor.

With the controller on, and measuring from the internal or remote probe, depending on which sensor is being calibrated, set the controller setpoint to the desired temperature. When the bath reaches this setpoint and stabilizes, measure the actual bath temperature with an external calibrated thermometer. Press in quick succession “1” “.” “ENTER”. The message 1-CAL # will appear followed by the flashing setpoint. Now enter in the actual bath temperature as measured by the calibrated thermometer and press ENTER. The display will now show the calibrated temperature and all temperatures will have this offset added to them.

Calibration clear: At any point the calibration data from a One or Two-point cal can be erased by quickly pressing “2” “.” “CLEAR”. This procedure clears the calibration data only for the selected probe.

High Temperature/ Low Liquid Level Safety

To protect your application, the adjustable High Temperature/Low Liquid Level Safety (HIGH TEMP/LOW LEVEL) ensures the heater will not exceed temperatures which can cause serious damage to your unit. A single temperature sensor, located on the heater coils in the bath, monitors both conditions. A High Temperature/Low Liquid Level fault occurs when the temperature of the sensor exceeds the set temperature limit.

In the event of a fault, the unit will shut down. The cause of the fault must be identified and corrected before the unit can be restarted.

The safety on single heater systems is not preset and must be adjusted during initial installation or if the unit is moved. Units with a boost heater have an additional nonadjustable safety located behind the main safety. It has a red reset button but no adjustment knob.

To set the safety, locate the HIGH TEMP/LOW LEVEL SAFETY adjustment dial on the right side of the pump box. Turn the dial fully clockwise and press the red RESET switch. The RESET switch is located next to the adjustment dial. **NOTE:** For units without a reset switch turn the power switch off then back on.

Start the unit. Adjust the setpoint for a few degrees higher than the highest desired fluid temperature and allow the bath to stabilize at the temperature setpoint. Turn the HIGH TEMP/LOW LEVEL SAFETY dial counter-clockwise until you hear a click and the unit shuts down. The red FAULT LED on the temperature controller will light to indicate a fault has occurred.

Cool the bath and then, without moving the adjustment dial, press the red RESET switch or turn the power switch off then back on.

NOTE: For units with a reset switch, the minimum high temperature safety setting is 50°C. For units without a reset switch the safety has a temperature range of 0°C to 180°C.

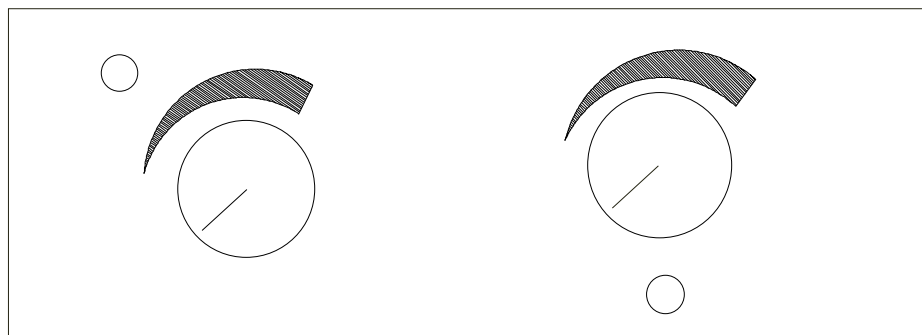

High Temperature/Low Liquid Level Safety
(Some units do not have a reset switch)

Section V Maintenance



To avoid electrical shock, disconnect the mains cord prior to removing any access panels or covers.

Service Contracts

ThermoNESLAB offers on-site Service Contracts that are designed to provide extended life and minimal down-time for your unit. For more information, contact our Service Department (see Preface, After-sale Support).

Condenser

For proper operation, the unit needs to pull substantial amounts of air through a condenser. A build up of dust or debris on the fins of the condenser will lead to a loss of cooling capacity.

Periodic vacuuming of the condenser is necessary. To access the condenser the front grille must be removed.



The unit must be turned off before the front panel is removed.

RTE-111's have a one-piece grille assembly. Simply pull forward to remove.

RTE-211 and RTE-221 units have a two piece grille assembly. First remove the left (blue-colored) section by simply pulling it forward. Pull forward on the remaining (white-colored) section to remove it.

The frequency of cleaning depends on the operating environment. After initial installation, we recommend a monthly visual inspection of the condenser. After several months, the frequency of cleaning will be established.

Reservoir Cleaning

Routine cleaning can be achieved by simply sponging down the seamless stainless steel tank with tap water. (Dish washing detergent may be used but the tank must be thoroughly rinsed.)

To gain access to the entire reservoir the pump box and reservoir cover should be removed.

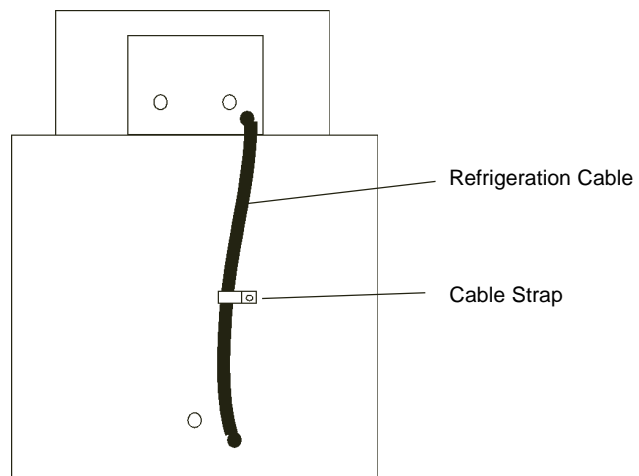

Remove the line cord from the rear of the unit and then remove the four screws (two on each side) securing the reservoir's cover.

To get slack on the refrigeration cable, remove the cable strap. The cable itself does not need to be disconnected.

Turn the cover assembly over and carefully place it on a supporting platform.

Algae

To restrict the growth of algae in the bath, we recommend the bath cover be kept in place and that all circulation lines be opaque. This will eliminate the entrance of light required for the growth of most common algae.

ThermoNESLAB recommends the use of Chloramine-T, 1 gram per 3.5 liters.

Section VI Troubleshooting

Checklist

Unit will not start

Make sure the voltage of the power source meets the specified voltage, $\pm 10\%$. Refer to the serial number label on the rear of the unit to identify the specific electrical requirements of your unit.

Check the High Temperature/Low Liquid Level Safety. If the FAULT light is on, make sure the fluid level in the bath is between the marks in the baffle and the HIGH TEMP/LOW LEVEL SAFETY setting is greater than the fluid temperature. Push the RESET switch(es) or, for units without a reset switch, turn the power switch off then back on and attempt to restart.

Loss of cooling capacity

Be sure the cooling capacity of the unit has not been exceeded if circulating to an external system.

When the unit is shut off, wait approximately five minutes before restarting. This allows time for the refrigeration pressures to equalize. If the pressures are not allowed to equalize, the compressor will short-cycle (clicking sound) and no cooling will occur.

Proper ventilation is required for heat removal. Make sure ventilation through the front and rear panels is not impeded and the panels are free of dust and debris.

Ice build up on the cooling coils can act as insulation and lower the cooling capacity. Raise the temperature of the bath to de-ice the cooling coil and increase the concentration of non-freezing fluid.

No external circulation

Make sure the stainless steel plugs on the PUMP INLET and PUMP OUTLET have been removed.

Check for obstructions, kinks, or leaks in the circulation tubing.

Circulation will cease when the pump head has been exceeded.

Continued on next page.

No communication between bath's microprocessor and your computer

Ensure the bath's microprocessor parameters (baud rate, parity etc.) match your computer requirements.

Ensure the RS-232 light is on steady. See page 12 for details. **NOTE:** You cannot input data from the keypad when the RS-232 mode is enabled.

Check the cable. The microprocessor reads data on pin 2 and transmit data on pin 3. Ensure the cable is correctly connected. Computer 25-pin and 9-pin communication ports usually have different conventions.

Ensure the only pins connected to the microprocessor are 2, 3 and 5. All other pins must *not* be connected.

Keypad locked up

NOTE: When communications is enabled, or a program is running, data entry and many keypad functions are disabled. This is normal operation.

If necessary, remove computer cable. Turn off the bath using the main power switch on the side of the unit. While holding the "0" button on the keypad, turn the unit back on. The Main Display will read OFF.

This will also restore the factory preset PID values and also reset the communication parameters and buffer. See Restoring Factory Preset Values on page 21.

Service Assistance and Technical Support

If, after following these troubleshooting steps, your unit fails to operate properly, contact our Customer Service Department for assistance (see Preface, After-sale Support). Before calling, please obtain the following information:

- Part number*
- Serial number*
- Voltage of unit*
- Voltage of power source*

In addition to arranging warranty service, our Service Department can provide you with a wiring diagram and a complete list of spare parts for your unit. Before calling, please obtain the following information:

- Part number*
- Serial number*

Appendix A — RS232

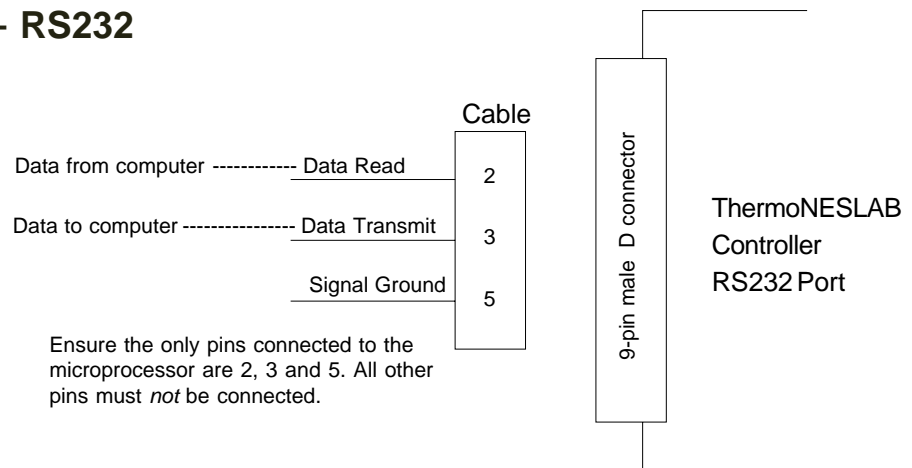

The unit can be controlled through your computer's serial port by using a standard 9-pin RS232 connection on the rear of the temperature controller. Data transmit of the serial port connects to data read (pin 2) of the bath. Data read of the serial port connects to the data transmit (pin 3) of the bath.

NOTE: Do not use a cable that connects to the unused pins on the bath communications port. This may cause a communication fault. Communication cables are available from ThermoNESLAB. Contact our sales department for additional information.

With a cable properly connected to the controller press RS232, the RS232 LED will start to flash. Press ENTER while the LED is flashing and the RS232 LED will come on steady indicating your computer's serial port can control the unit's operation.

In this mode of operation you cannot manually input data with the keypad. You can, however, observe the setpoint and/or alarm temperature limits by pressing the appropriate button on the controller. Your computer can be used to operate all modes of operation.

NOTE: When serial communications is enabled, and a temperature program is running, no keypad functions are allowed.

Communication Commands

All commands must be entered in the exact format shown in the following four tables. Do not send a [LF] (line feed) after the [CR]. Ensure the specified letter case is used. The tables on the next few pages show all commands available, their format and responses. Controller responses are either the requested data, an exclamation point (!) if the command was properly executed, or a question mark (?) if the controller could not execute the command. A question mark response indicates either an improper command format or an attempt to enter settings that are outside the allowable range. The controller response *must* be received before sending the next command.

NOTE: All responses from the bath are terminated with a single [CR] only. Wait for your computer to respond before sending the next command.

TABLE 1 GENERAL COMMANDS

Command Echo	SEi[CR]
Echo: i = 1, No echo: i = 0 (control returns commands)	
Set Setpoint	SSxxx.xx[CR]
-30.00 to +150.00°C or -22.00 to +300.00°F	
Read Setpoint	RS[CR]
Read Main Probe Temperature	RT[CR]
Read Remote Probe Temperature	RR[CR]
Turn Control On or Off	SOi[CR]
On: i = 1, Off: i = 0	
Set Power Status Flag	SWi[CR]
Set: i = 1, Reset i = 0 (reset when controller power is lost)	
Read Power Status Flag	RW[CR]
Read F or C Units	RU[CR]

TABLE 2 ALARM COMMANDS

Set High Alarm Limit	SHxxx.xx[CR]
Same range as setpoint	
Read High Alarm Limit	RH[CR]
Set Low Alarm Limit	SLxxx.xx[CR]
Same range as setpoint	
Read Low Alarm Limit	RL[CR]
Read Alarm Status	RF[CR]
Returns: 0 = no alarm, 1 = alarm	

TABLE 3 CONTROL COMMANDS

Set Proportional Bandwidth	SPxx.xx[CR]
0.10 to 10.00 % of full scale	
Read Proportional Bandwidth	RP[CR]
Set Integral Compensation	SIxx.xx[CR]
0.00 to 10.00 repeats/minute	
Read Integral Compensation	RI[CR]
Set Derivative Compensation	SDx.xx[CR]
0.00 to 1.00 minutes	
Read Derivative Compensation	Rd[CR]
Main/Remote Probe Selection	Sri[CR]
Main: i = 0, Remote: i = 1	
Compressor Inhibit	SCi[CR]
Inhibit: i = 0, Enable: i = 1	

TABLE 3 CONTROL COMMANDS (Continued)

Boost Heater Inhibit Inhibit: i = 0, Enable: i = 1	SBi[CR]
Max Mode Inhibit Inhibit: i = 0, Enable: i = 1	SMi[CR]

TABLE 4 PROGRAMMING COMMANDS

Set Step Setpoint n = step number	SYn,xxx.xx[CR]
Read Step Setpoint	RYn[CR]
Set Step Period n = step number	SXn,xxx.xx[CR]
Read Step Period	RXn[CR]
Read Number of Steps	Rs[CR]
Set Number of Loops 0 to 9999 additional loops after first program execution	SKxxxx[CR]
Read Number of Loops	RK[CR]
Set Hold Status Hold: i = 1, No hold: i = 0	SZi[CR]
Pause/Resume Program Resume: i = 1, Pause: i = 0	SGi[CR]
End Program	SR[CR]
Read Elapsed Step Time	RE[CR]
Select Program Number	SVx[CR]
Read Selected Program Number	RV[CR]
Read Current Period	RC[CR]
Skip Ahead One Period	SJ[CR]

To set the communications data format the controller must be deactivated (Main display indicates OFF). Press the RS232 button. The word "Baud" will momentarily appear followed by the current baud rate (9600, 4800, 1200, 600 or 300). Use the keypad to enter the desired change, if any. Press ENTER and "db" will momentarily appear followed by the current number of data bits setting. Again, use the keypad to enter any desired change (7 or 8) and then press ENTER. "Sb" will momentarily appear followed by the current number of stop bits (1 or 2). Change, if needed, and press ENTER and "PAR" will momentarily appear followed by the current parity control setting (0 = none, 1 = odd, 2 = even). Change, if needed, and press ENTER.

To manually exit this mode of operation press RS232. The RS232 LED will start to flash. Press the CLEAR button and the RS232 LED will extinguish.

Communication Command Protocol

The following table lists the communication command protocol for programming the controller via a computer. Use the Ctrl - C key combination to clear the controller receiving buffer if an erroneous character is detected.

FUNCTION	SYNTAX ¹	RETURN MESSAGE ²
SET SETPOINT	SSxxx.xx[CR]	![CR]
SET LOW LIMIT	SLxxx.xx[CR]	![CR]
SET HIGH LIMIT	SHxxx.xx[CR]	![CR]
SET PROPORTIONAL BAND ³	SPxx.xx[CR]	![CR]
SET INTEGRAL ⁴	SIxx.xx[CR]	![CR]
SET DERIVATIVE ⁵	SDx.xx or Sdx.xx[CR]	![CR]
COMPRESSOR INHIBIT	SCi[CR]	![CR]
BOOST HEATER INHIBIT	SBi[CR]	![CR]
MAX MODE INHIBIT	SMi[CR]	![CR]
SET POWER STATUS FLAG	SWi[CR]	![CR]
SET ON/OFF	SOi[CR]	![CR]
SELECT PROGRAM NUMBER	SVx[CR]	![CR]
SET STEP SETPOINT	SYn,xxx.xx[CR]	![CR]
SET STEP PERIOD	SXn,xxx.x[CR]	![CR]
SET NUMBER OF PERIODS	Ssn[CR]	![CR]
SET NUMBER OF LOOPS	SKxxx[CR]	![CR]
SET HOLD STATUS	SZi[CR]	![CR]
END PROGRAM	SR[CR]	![CR]
ECHO CONTROL ⁶	SEi[CR]	![CR]
REMOTE SENSOR CONTROL	Sri[CR]	![CR]
SUSPEND/RESUME PROGRAM	SGi[CR]	![CR]
SKIP AHEAD ONE PERIOD	SJ[CR]	![CR]
READ SETPOINT	RS[CR]	xxx.xx[CR]
READ TEMPERATURE	RT[CR]	xxx.xx[CR]
READ ALARM STATUS	RF[CR]	![CR]
READ REMOTE TEMPERATURE	RR[CR]	xxx.xx[CR]
READ UNITS	RU[CR]	C[CR] or F[CR]
READ CURRENT PERIOD	RC[CR]	xx[CR]
READ ELAPSED TIME	RE[CR]	xxx.x[CR]
READ LOW LIMIT	RL[CR]	xxx.xx[CR]
READ HIGH LIMIT	RH[CR]	xxx.xx[CR]
READ PROPORTIONAL BAND	RP[CR]	xx.xx[CR]
READ INTEGRAL	RI[CR]	xx.xx[CR]
READ DERIVATIVE	Rd[CR]	x.xx[CR]
READ PROGRAM NUMBER	RV[CR]	x[CR]
READ STEP SETPOINT	RYn[CR]	xxx.xx[CR]
READ STEP PERIOD	RXn[CR]	xxx.x[CR]
READ NUMBER OF STEPS	Rs[CR]	x[CR]
READ NUMBER OF LOOPS	RK[CR]	xxx[CR]
READ POWER STATUS	RW[CR]	x[CR]

1. x = ASCII digit, i = 0 (OFF or STOP) i = 1 (ON or GO), n = step number.

2. Ensure the return message is correct. If not, resend or troubleshoot communication lines.

3. Factory preset at 0.6%.

4. Factory preset at 0.25 repeats per minute.

5. Factory preset at 0.05 minutes.

6. Allows computer to compare send signal to receive signal.

Remote Programming

The bath can be programmed and controlled by a remote computer. Enter step setpoints using the SYn command, time periods using the SXn command, number of loops using the SKxxx command and number of periods in the program using the Ssn command. Start the program using SG1 and suspend the program using SG0. When the program is finished it will stop automatically. If needed, SR will end the program at any time. Here is a four setpoint, two loop example:

SV1[CR]	Select program number one
SY1,25.00[CR]	First setpoint = 25.00 degrees
SX1,20.0[CR]	First period = 20.0 minutes
SY2,40.00[CR]	Second setpoint = 40.00 degrees
SX2,60.0[CR]	Second period = 60.0 minutes
SY3,40.00[CR]	Third setpoint = 40.00 degrees
SX3,45.0[CR]	Third period = 45.0 minutes
SY4,25.00[CR]	Fourth setpoint = 25.00 degrees
Ss3[CR]	Program has three periods
SK2[CR]	Execute the program three times total
SG1[CR]	Begin executing program
SG0[CR]	Temporarily suspend the program
SR[CR]	Stop the program before it is finished

Appendix B

International Quick Reference Guides

RTE mikroprozessorgesteuert Kurzbedienungsanleitung

Installation

Das Gerät verfügt über ein luftgekühltes Kühlsystem. Die Luft wird an der Vorderseite angesaugt und strömt an der Rückseite aus. Das Gerät muß so plaziert werden, daß der Luftstrom nicht behindert wird. Bei ungenügender Ventilation wird die Kühlleistung reduziert und kann in extremen Situationen zu einem Ausfall des Kühlsystems (Kompressors) führen.

Aufstellorte mit hoher Staubentwicklung sollten vermieden werden, und es sollte eine regelmäßige Reinigung des Gerätes durchgeführt werden. Um einwandfrei zu funktionieren, muß das Gerät große Luftmengen durch den Kondensator ansaugen. Bei Staub- und Schmutzablagerungen auf dem Kondensatorheizkörper kommt es zu einem Verlust von Kühlleistung.

Das Gerät behält seine maximale Kühlleistung bis zu einer Umgebungstemperatur von ca. +24°C.

Vergewissern Sie sich, daß die Spannung Ihrer Stromanschlüsse mit der für das Gerät vorgesehenen Spannung übereinstimmt ($\pm 10\%$).

Die Schlauchanschlüsse (1/4 Zoll MPT) des Gerätes befinden sich an der Rückseite und sind mit PUMP INLET und PUMP OUTLET bezeichnet. Entfernen Sie die Kappen, falls externe Zirkulation gewünscht wird. Schließen Sie den PUMP OUTLET-Anschluß an den Eingang Ihres Instruments und den PUMP INLET-Anschluß an den Ausgang Ihres Instruments an.

Füllen Sie das Reservoir bis zu einem Stand, der zwischen den horizontalen Markierungen liegt, die auf dem Blech markiert sind, das den Arbeitsbereich von der Pumpeneinheit trennt.

Verwenden Sie niemals entflammbare oder Korrosion verursachende Flüssigkeiten. Die gewählte Flüssigkeit muß eine Viskosität von maximal 50 Centistokes bei der niedrigsten möglichen Arbeitstemperatur haben. Für den Betrieb im Arbeits-Temperaturbereich von +8°C bis +80°C empfiehlt ThermoNESLAB Leitungswasser als Kühlmittel.

Wenn sie zu einem externen System zirkulieren, sollten Sie zusätzliche Kühlfüssigkeit zur Hand haben, um den Kühlfüssigkeitsstand in den Zirkulationsleitungen und dem externen System beibehalten zu können.

Betreiben Sie das Gerät niemals mit leerem Arbeitsbereich!

Inbetriebnahme

Vor Inbetriebnahme des Gerätes vergewissern Sie sich bitte, daß die elektrischen Anschlüsse und die Rohr- u. Schlauchanschlüsse sachgemäß installiert sind und daß das gesamte System mit Kühlfüssigkeit gefüllt ist.

Geräte, die bei 220 Volt betrieben werden, verfügen über einen Stromkreisunterbrecher auf der Rückseite des Gerätes. Vergewissern Sie sich, daß dieser auf ON gestellt ist. Um das Gerät einzuschalten, müssen Sie den I/O-Schalter auf „I“ stellen. Die Power-Lampe leuchtet auf, wenn das Gerät in Betrieb ist. Um das Gerät abzuschalten, muß der I/O-Schalter auf „O“ gestellt werden.

Nach dem Ausschalten des Gerätes sollten Sie vor dem Wiedereinschalten ca. 5 Minuten warten, damit das Kühlsystem einen Druckausgleich durchführen kann. Beachtet man diese Wartezeit nicht, kommt es zu kurzen Schaltfrequenzen des Kompressors und eine Kühlung ist nicht möglich.

Mikroprozessor-Temperatursteuerung

Bitte schlagen Sie Sektion IV der Betriebsanleitung auf, um die kompletten Bedienungsanweisungen für die Mikroprozessorsteuerung nachzulesen.

Wartung

Überprüfen Sie regelmäßig die Kühlfüssigkeit im Reservoir. Sollte eine Säuberung notwendig sein, spülen Sie das Reservoir mit einer speziellen Reinigungsflüssigkeit, die mit dem Umlaufsystem und der Kühlfüssigkeit kompatibel ist.

Das Kühlmittel sollten Sie regelmäßig erneuern. Wenn Sie das Gerät bei niedrigen Temperaturen betreiben, erhöht sich mit der Zeit der Wasseranteil in der Kühlfüssigkeit. Dies führt zum Verlust von Kühlkapazität.

Vor Ersetzen der Kühlfüssigkeit erhöhen Sie bitte die Betriebstemperatur des Gerätes so weit, daß die Kühlsolen eisfrei sind.

Regelmäßiges Absaugen des Kondensator-Heizkörpers ist erforderlich. Die Reinigungshäufigkeit hängt von der Betriebsumgebung ab. Eine monatliche Überprüfung des Kondensators ist empfehlenswert. So werden Sie nach einigen Monaten einen Reinigungsrythmus gefunden haben.

RTE Kvik reference.

Installation:

Opstilles i rene omgivelser. Dette system er luftkølet, og luften trækkes ind forfra og udledes bagtil, sørg derfor for god cirkulation om instrumentet.

Steder med meget støv skal undgås, og periodisk rensning skal udføres, hvis utilsigtet nedbrud skal undgås. Opbygning af støv vil medføre fald i kølekapasiteten og i værste fald overophedning af systemet.

Check at netspændingen er den nominelle 240V +/- max. 10% og temperatur max. 24° C ved optimal udnyttelse.

Slangetilgang er på bagsiden mærket „Pump inlet“ til indgang på dit emne og „Pump outlet“ på udgangen.

Ledningsvand (ionbyttet) kan anvendes mellem +8 til 80° C, under +8° C skal væsken blandes op med ethylenglycol.

Fyldning af reservoiret foregår ved at fjerne panelet, som er forsynet med fingerskruer, og påfyld egnet rent kølevæske, max 5 cm fra toppen.

Betjening:

Før opstart checkes elektriske forbindelser, slangeforbindelser og væskestand.

Microprocessorkontrol:

Se venligst Section IV i manualen.inde, skal temperaturen ændres drejes herefter på „Adjust“ knappen. Slip „Display“ knappen og aktuel temperatur vises.

Periodisk vedligeholdelse:

Check standen af væske periodisk. Check med mellemrum vakuemet på pumpesiden, rens systemet og check for aflejringer, vækst, utætheder, check vakuumpumpen med kondenser og evt. filtre. Husk åben aldrig instrumentet uden strømmen er afbrudt, og strømkablet er taget ud!

RTE met Microprocessor, Handleiding voor snelle installatieprocedure.

Installatie

Het apparaat heeft een luchtgekoeld koelsysteem. Lucht wordt aangezogen aan de voorkant van het apparaat en weer vrijgegeven via de achterkant. Plaats het apparaat op een dusdanige manier dat de luchttoevoer en afvoer niet worden belemmerd.

Het is aan te raden stoffige ruimtes te vermijden en de condensor regelmatig schoon te maken. Voor een optimale werking dient via de condensor een voldoende hoeveelheid lucht te circuleren. Een opeenhoping van stof en vuil op de condensor kan leiden tot een verlies van koelcapaciteit.

Het apparaat behoudt haar integrale capaciteit bij een omgevingstemperatuur tot ongeveer 24°C.

Let erop dat de netspanning gelijk is aan het aangegeven voltage, +/- 10%.

De slangaansluitingen zijn bevestigd aan de achterkant van het apparaat en zijn voorzien van het label PUMP INLET en PUMP OUTLET. Deze aansluitingen zijn 1/4 inch MPT. Verwijder de pluggen indien externe circulatie gewenst is. Bevestig de PUMP OUTLET aan de ingang van uw applicatie. Bevestig de PUMP INLET plug aan de uitgang van uw applicatie.

Vul het reservoir tot het volgende niveau: tussen de horizontale markeringen op de roestvrijstalen scheidingsplaat, die de werkruimte van het pompgedeelte scheidt.

Gebruik nooit brandbare of andere koelvloeistoffen, die het toestel kunnen aantasten. De vloeistof die u gaat gebruiken moet een viscositeit hebben van 50 centistokes of minder bij lage temperatuurwerking. Kraanwater wordt in het algemeen aanbevolen wanneer u bij temperaturen werkt van +8°C tot +80°C.

Wanneer u wilt circuleren naar een extern systeem, dient u altijd extra vloeistof achter de hand te houden om het juiste vloeistofniveau, zowel in het interne als het externe gedeelte van het systeem, te handhaven.

Gebruik het apparaat nooit wanneer het reservoir leeg is.

Operationeel gebruik

Alvorens het apparaat in gebruik te nemen, dient u eerst alle elektrische- en slangaansluitingen te controleren. Tevens dient u te controleren of het systeem gevuld is met koelvloeistof.

220 Volt apparaten hebben een z.g. "circuit breaker" aan de achterkant van het apparaat. Controleer of deze in werking is gesteld. Om het apparaat te starten, gelieve de I/O knop aan de zijkant van het apparaat te draaien naar de I positie. Het lampje zal oplichten als indicatie dat het systeem in werking is gesteld. Om het apparaat uit te zetten, gelieve de I/O knop naar de O positie te draaien.

Wanneer het apparaat uitgeschakeld is, gelieve 5 minuten te wachten alvorens u het apparaat weer in werking stelt. Deze tijd is nodig om de koeldruk gelijk te stellen. Indien dit niet gebeurt, zal shortcycle binnen de compressor optreden (klikkend geluid) en er vindt geen koeling plaats.

Microprocessor Controller

Voor verdere (complete) instructies betreffende de bediening van de microprocessor regelaar, zie hoofdstuk IV van deze handleiding.

Periodiek Onderhoud

De vloeistof in het reservoir dient regelmatig gecontroleerd te worden. Indien reiniging noodzakelijk is, zal het reservoir schoongespoeld moeten worden met een vloeistof welke verenigbaar is met het koelsysteem en de koelvloeistof.

De koelvloeistof dient regelmatig vervangen te worden. Wanneer u werkt bij lage temperaturen, zal de concentratie van het water in de koelvloeistof gedurende die periode toenemen, wat kan leiden tot verlies van koelcapaciteit.

Alvorens u de koelvloeistof vervangt, dient u de operationele temperatuur van het apparaat om de koelspiralen vrij te maken van ijs.

Het periodiek reinigen van de condensor is noodzakelijk. Het aantal malen dat dit moet gebeuren hangt af van de omgeving waar het apparaat staat opgesteld en wordt gebruikt. Wij raden een algemene maandelijkse inspectie van de condensor aan na de installatie. Na enkele maanden zal duidelijk zijn hoe vaak men het apparaat dient te reinigen.

Kortfattad Bruksanvisning för RTE Mikroprocessor

Installation

Maskinen har ett luft kylt kylnings system. Luft tas in på framsidan av maskinen och släpps ut på sidan och baksidan av maskinen. Ställ maskinen så att intaget och uttaget inte är blockerade. Otillräcklig ventilation leder till minskad kylningskapacitet och i vissa fall kan kompressorn gå sönder.

Undvik dammiga områden och rengör maskinen periodvis. För att fungera ordentligt måste mycket luft passera genom kondensorn. Damm och smuts i kondensorn leder till minskad kylnings kapacitet.

Maskinen har full kylningskapacitet upp till en temperatur av +75°F (24°C).

Röranslutning finns på baksidan av maskinen och har följande beskrivning: SUPPLY och RETURN. Anslutningarna är 1/4 inch MPT. Ta bort de skyddande plast bitarna från röranslutningarna. Anslut SUPPLY kopplingen till intaget av din anordning och RETURN kopplingen till uttaget.

För att fylla tanken, lösgör skruvarna och ta bort luckan. Ta bort tank pluggen och fyll tanken med ren kylnings vätska.

Använd aldrig eldfarliga eller frätande vätskor. Vätskan måste ha en viskositet av 50cST eller mindre vid den lägsta användnings temperaturen. Vanligt kran vatten är den rekommenderade vätskan vid en temperatur mellan +8°C och +80°C. Under +8°C måste en vätska som inte fryser användas. En blandning av vanligt vatten och etylenglykol (laboratorie kvalitet) föreslås.

Ha extra vätska redo om din anordning kräver det så att den rätta nivån behålls i cirkulations sytemet.

Användning

Innan maskinen startas, kontrollera alla elektriska och alla rör anslutningar. Se till att cirkulations systemen har fyllts med vätska.

220V maskiner har en ström brytare på baksidan av maskinen. För att starta maskinen, sätt I/O knappen på sidan av maskinen på I. Lampan lyser för att visa att maskinen är på. Sätt knappen på O för att stänga av den.

Under normal användning bör REFRIGERATION knappen vara på när maskinen används under 50°C. MIN används när temperaturen är under 0°C och mellan 30°C och 50°C. Använd MAX från 0°C till 30°C.

Sätt start knappen på ON för att starta maskinen. COOL och IDLE på framsidan visar statusen på kylningssystemet. Cool lyser när värme tas bort från köldmedlet. När temperaturen närmar sig den förbestämda önskade temperaturen kommer de två att växla.

Efter att maskinen stängts av, vänta 5 minuter innan maskinen sätts på igen för att låta kylningstrycken att utjämnas. Ingen kylning kommer att utföras om inte trycken tillåts att utjämnas.

Mikroprocessor Kontroll

Se del IV av instruktions boken för en utförlig beskrivning av Mikroprocessor kontrollen.

Periodiskt Underhåll

Inspektera vätskan i tanken periodiskt. Om rengöring är nödvändigt, spola tanken med en rengörings vätska som är förenlig med cirkulationssystemet och kylvätskan.

Kylvätskan bör bytas periodvis. När enheten används vid låga temperaturer kommer vätskans koncentration av vatten att öka vilket leder till minskad kylningskapacitet.

Periodisk rengöring av kondensorn är nödvändig. Hur ofta rengöring är nödvändig beror på miljön. Vi rekommenderar en visuell inspektion av kondensorn varje månad.

PROCEDIMIENTOS DE OPERACION DE REFERENCIA RAPIDA

PARA EL RTE CON MICROPROCESADOR

INSTALACION

La unidad tiene un sistema de refrigeración por aire. El aire es dirigido hacia el frontal de la unidad y se descarga por la parte trasera y lateral. Sitúe la unidad para no impedir la entrada y descarga. Una ventilación inadecuada causará una reducción en la capacidad de enfriamiento y, en casos extremos, un fallo en el compresor.

Deben evitarse las zonas excesivamente polvorizadas y debe instituirse un calendario de limpiezas periódicas. Para un funcionamiento adecuado, la unidad necesita empujar una cantidad sustancial de aire a través de un condensador. Un cúmulo de polvo o residuos en las aletas del condensador ocasionaría una pérdida de capacidad de enfriamiento.

La unidad retendrá su capacidad completa en temperaturas ambiente de hasta aproximadamente + 75 °C.

Asegúrese de que el voltaje de la fuente de energía sea igual que el voltaje especificado, +/- 10%.

Las conexiones de tuberías están situadas en la parte trasera de la unidad y están marcadas como PUMP INLET y PUMP OUTLET. Estas conexiones son 1/4" MPT. Saque las tapas cuando requiera circulación externa. Conecte el adaptador PUMP OUTLET a la entrada de su aplicación. Conecte el adaptador PUMP INLET a la salida de su aplicación.

Llene el reservorio a un nivel entre los marcadores horizontales situados en la puerta de acero inoxidable que separa la zona de trabajo de la bomba.

No utilice nunca fluidos inflamables o corrosivos. El fluido elegido debe tener una viscosidad de 50 centistokes o menos a las temperaturas de operación más bajas. Se recomienda agua corriente para funcionar entre + 8 °C a + 80 °C.

Cuando bombee a un sistema externo, tenga fluido extra a mano para mantener el nivel apropiado tanto en las líneas circulantes como en el sistema externo.

Nunca haga funcionar el instrumento con el área de trabajo vacía.

OPERACION

Antes de poner en marcha la unidad, compruebe todas las conexiones eléctricas y de tuberías. Asegúrese de que el sistema circulador se ha llenado con fluido.

Las unidades de 220 V. tienen un cortador de circuito en la parte trasera de la unidad. Asegúrese de que está en posición ON. Para poner en marcha la unidad, ponga el interruptor I/O situado en el lateral de la unidad en posición I. La lámpara Power se iluminará para indicar que el sistema está funcionando. Para apagarlo, ponga el interruptor de encendido en posición O.

Cuando se apaga la unidad, espere aproximadamente cinco minutos antes de volver a ponerla en marcha. Esto da tiempo para que las presiones de refrigeración se ecualicen. Si no se permite ecualizarse las presiones, el compresor se cortocircuitará y no enfriará.

CONTROLADOR POR MICROPROCESADOR

Ver Sección IV de este manual para instrucciones completas para utilizar el controlador por microprocesador.

MANTENIMIENTO PERIODICO

Inspeccione periódicamente el fluido del reservorio. Si es necesaria una limpieza, rocíe el reservorio con un fluido de limpieza compatible con el sistema de circulación y el fluido refrigerante.

El fluido refrigerante debe sustituirse periódicamente. Cuando se funciona a baja temperatura, la concentración de agua en el fluido refrigerante aumentará con el tiempo, ocasionando una pérdida de capacidad refrigerante.

Antes de cambiar el fluido refrigerante, suba la temperatura de operación de la unidad para descongelar los serpentines de refrigeración.

Es necesario un vaciado periódico de las aletas del condensador. La frecuencia de limpieza depende del entorno en que funciona el aparato. Recomendamos una inspección visual mensual del condensador después de la instalación inicial. Después de varios meses, quedará establecida la frecuencia de limpieza.

Appendix C PROGRAMMING SOFTWARE

NEScom Software

The ThermoNESLAB Communications Software is a user friendly software that allows you to automate your temperature control process. The software includes a 3½" disk, comprehensive operator's manual and a toll-free number to a trained technical staff.

NEScom Software allows you to write custom temperature programs for our Digital or Microprocessor based temperature control apparatus. Choose upper or lower temperature limits and monitor system status with an alarm. NEScom can also record your results on a user selectable graph. NesCom must be used with an IBM or 100% compatible computer.

Select from easy to use product icons.

Create graphs and charts.

Easily configure ramping functions which set the setpoint over time.

View pop-up alarm windows which display if an alarm condition occurred.

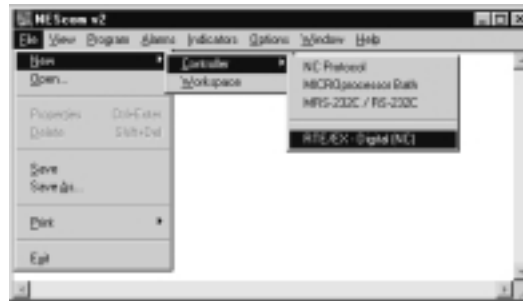

Select software functions from the easy to use pulldown menus.

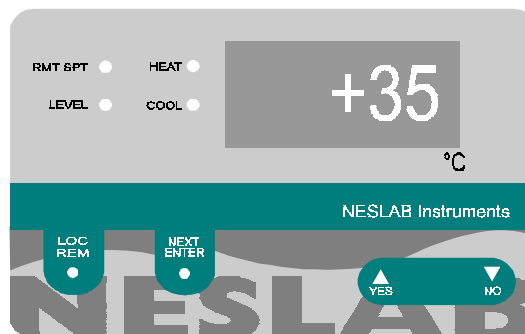

View a virtual controller screen which allows remote monitoring and operation of product control panel.

WARRANTY

ThermoNESLAB Instruments, Inc. warrants for 12 months from date of shipment any ThermoNESLAB unit according to the following terms.

Any part of the unit manufactured or supplied by ThermoNESLAB and found in the reasonable judgment of ThermoNESLAB to be defective in material or workmanship will be repaired at an authorized ThermoNESLAB Repair Depot without charge for parts or labor. The unit, including any defective part must be returned to an authorized ThermoNESLAB Repair Depot within the warranty period. The expense of returning the unit to the authorized ThermoNESLAB Repair Depot for warranty service will be paid for by the buyer. ThermoNESLAB's responsibility in respect to warranty claims is limited to performing the required repairs or replacements, and no claim of breach of warranty shall be cause for cancellation or rescision of the contract of sales of any unit. With respect to units that qualify for field service repairs, ThermoNESLAB's responsibility is limited to the component parts necessary for the repair and the labor that is required on site to perform the repair. Any travel labor or mileage charges are the financial responsibility of the buyer.

The buyer shall be responsible for any evaluation or warranty service call (including labor charges) if no defects are found with the ThermoNESLAB product.

This warranty does not cover any unit that has been subject to misuse, neglect, or accident. This warranty does not apply to any damage to the unit that is the result of improper installation or maintenance, or to any unit that has been operated or maintained in any way contrary to the operating or maintenance instructions specified in ThermoNESLAB's Instruction and Operation Manual. This warranty does not cover any unit that has been altered or modified so as to change its intended use.

In addition, this warranty does not extend to repairs made by the use of parts, accessories, or fluids which are either incompatible with the unit or adversely affect its operation, performance, or durability.

ThermoNESLAB reserves the right to change or improve the design of any unit without assuming any obligation to modify any unit previously manufactured.

THE FOREGOING EXPRESS WARRANTY IS IN LIEU OF ALL OTHER WARRANTIES, EXPRESSED OR IMPLIED, INCLUDING BUT NOT LIMITED TO WARRANTIES OR MERCHANTABILITY AND FITNESS FOR A PARTICULAR PURPOSE.

ThermoNESLAB'S OBLIGATION UNDER THIS WARRANTY IS STRICTLY AND EXCLUSIVELY LIMITED TO THE REPAIR OR REPLACEMENT OF DEFECTIVE COMPONENT PARTS AND ThermoNESLAB DOES NOT ASSUME OR AUTHORIZE ANYONE TO ASSUME FOR IT ANY OTHER OBLIGATION.

ThermoNESLAB ASSUMES NO RESPONSIBILITY FOR INCIDENTAL, CONSEQUENTIAL, OR OTHER DAMAGES INCLUDING, BUT NOT LIMITED TO LOSS OR DAMAGE TO PROPERTY, LOSS OF PROFITS OR REVENUE, LOSS OF THE UNIT, LOSS OF TIME, OR INCONVENIENCE.

This warranty applies to units sold in the United States. Any units sold elsewhere are warranted by the affiliated marketing company of ThermoNESLAB Instruments, Inc. This warranty and all matters arising pursuant to it shall be governed by the law of the State of New Hampshire, United States. All legal actions brought in relation hereto shall be filed in the appropriate state or federal courts in New Hampshire, unless waived by ThermoNESLAB.