

Merlin Recirculating Chillers

ThermoNESLAB Manual P/N U00659

Rev. 11/09/00

**Installation
Operation
Basic Service**



Table of Contents

Preface

Compliance	2
Unpacking	2
Warranty	2
NES-care Extended Warranty Contract	2
After-sale Support	3

Section I Safety

Warnings	4
Additional Warnings	5

Section II General Information

Quick Reference Operating Procedures	7
Description	8
Specifications	8

Section III Installation and Operation

Site	12
Electrical Requirements	13
Plumbing Requirements	14
Fluids	14
Filling Requirements	15
Reservoir Tank Isolation Valves	15
Controller	16
Start Up/Shut Down	18
Setup/Tuning Loop	20

Section IV Options

Communication Connector	21
Remote Start/Stop	22
Reservoir Level Warning/Fault	23
Low Pump Flow Warning/Fault	23
Additional Accessories	23
Error Codes	24

Section V Maintenance and Service

Displaying Software Version Number	25
Cleaning	26
Algae	26
Leaks	27
PD Pressure Relief Valve	27
PD Pump Strainer	28
PD Pump Motor Lubrication	29
BOM Decoder	29

Section VI Troubleshooting

Checklist	30
Service Assistance	31

Appendix A Water Quality Standards and Recommendations

Appendix B RS-232 Serial Communications Protocol

Appendix C RS-485 Serial Communications Protocol

WARRANTY

Preface

Compliance

60 Hertz

CSA-C22.2 No 1010-1

UL-471, and UL-3101-1.

50 Hertz

Products tested and found to be in compliance with the requirements defined in the EMC standards defined by 89/336/EEC as well as Low Voltage Directive (LVD) 73/23/EEC can be identified by the CE label on the rear of the unit. The testing has demonstrated compliance with the following directives:

LVD, 73/23/EEC	Complies with IEC 1010-1:93
EMC, 89/336/EEC	EN 55011, Class A Verification
	EN50082-1:1992
	IEC 61000-4-2:1999
	IEC 61000-4-3:1998
	IEC 61000-4-4:1995
	IEC 61000-4-5:1995
	IEC 61000-4-6:1996

For any additional information, refer to the Letter of Compliance that shipped with the unit (Declaration of Conformity).

Unpacking

Retain all cartons and packing material until the unit is operated and found to be in good condition. If the unit shows external or internal damage, or does not operate properly, contact the transportation company and file a damage claim. Under ICC regulations, this is your responsibility.

Warranty

Units have a warranty against defective parts and workmanship for 24 months from date of shipment. See back page for more details.

***NES-care* Extended Warranty Contract**

- Extend parts and labor coverage for an additional year.
- Worry-free operation.
- Control service costs.
- Eliminate the need to generate repair orders.
- No unexpected repair costs.

Other contract options are available. Please contact ThermoNESLAB for more information.

After-sale Support

ThermoNESLAB is committed to customer service both during and after the sale. If you have questions concerning the unit operation, contact our Sales Department. If your unit fails to operate properly, or if you have questions concerning spare parts or Service Contracts, contact our Service Department.

Before calling, *please* obtain the following information:

- unit BOM number _____

- unit serial number _____

- unit software version _____

- voltage of power source _____

The unit's BOM and serial number label are located on the label rear of the unit. See page 25 for instructions on how to display the software version.

 NESLAB	NESLAB Instruments, Inc. Newington, NH 03801 U.S.A. (800)258-0830 / (603)436-9444	
	BOM#: 265102032000 100VOLT 60HZ 1PH 7AMP R134A 12OZ HIGH 300PSI LOW 150PSI	S/N: 199348017

See page 29 for instructions on how to decode your unit's BOM number.

Section I Safety

Warnings



Warnings are posted throughout the manual. These warnings are designated by an exclamation mark inside an equilateral triangle and text highlighted in bold. Read and follow these important instructions. Failure to observe these instructions can result in permanent damage to the unit, significant property damage, or personal injury or death.



The lightning flash with arrow symbol, within an equilateral triangle, is intended to alert the user to the presence of non-insulated "dangerous voltage" within the unit's enclosure. The voltage may be of significant magnitude to constitute a risk of electrical shock.

Make sure you read and understand all instructions and safety precautions listed in this manual before installing or operating your unit. If you have any questions concerning the operation of your unit or the information in this manual, please contact our Sales Department (see After-sale Support).

Never place the unit in a location where excessive heat, moisture, or corrosive materials are present.

The unit construction provides extra protection against the risk of electrical shock by grounding appropriate metal parts. The extra protection may not function unless the power cord is connected to a properly grounded outlet. It is the user's responsibility to assure a proper ground connection is provided.

Never connect the inlet or outlet fitting to your building water supply or any water pressure source.

Never use flammable or corrosive fluids with this unit. Highly distilled and deionized water may be aggressive and cause material corrosion. Please contact ThermoNESLAB before subjecting this unit to prolonged exposure to highly distilled or deionized water.

Do not use automotive antifreeze. Commercial antifreeze contains silicates that can damage the pump seals. Use of automotive antifreeze will void the manufacturer's warranty.

Additional Warnings

In addition to the specific warnings listed on the previous page the following general warnings apply to your unit:

Performance of installation, operation, or maintenance procedures other than those described in this manual may result in a hazardous situation and may void the manufacturer's warranty.

Transport the unit with care. Sudden jolts or drops can damage the refrigeration lines.

Observe all warning labels.

Never remove warning labels.

Never operate damaged or leaking equipment.

Never operate the unit without cooling fluid in the reservoir.

Always turn off the unit and disconnect the power cord from the power source before performing any service or maintenance procedures, or before moving the unit.

Never operate equipment with damaged power cords.

Refer service and repairs to a qualified technician.

Section II General Information

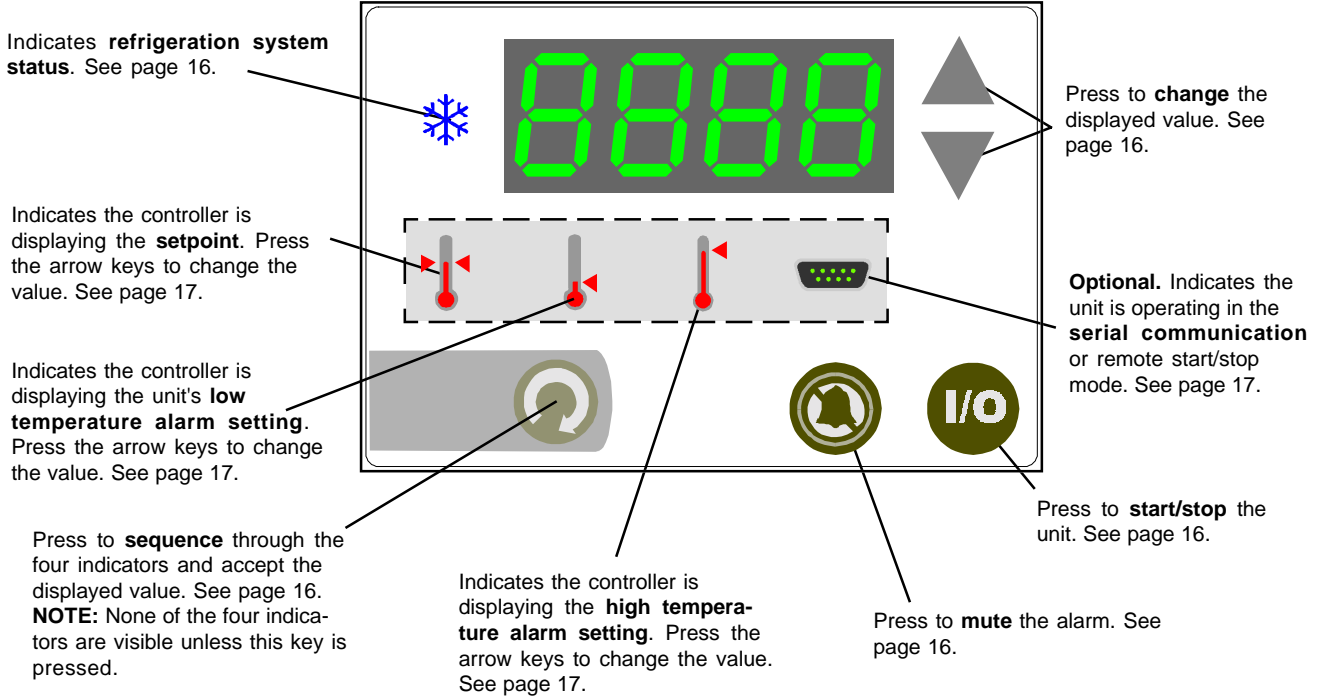

Reservoir Access Panel. See page 15.

Controller. See page 16.

Pressure Gauge. See page 18.



Indicates a **Merlin Operating Tip**.

Circuit Breaker. See page 18.



Optional

Communications Connector. See page 21.

Reservoir. See page 15.

Condenser Access Panel. See page 26.



Plumbing Return Connection. See page 14.



Plumbing Supply Connection. See page 14.



PD Pump Pressure Relief Valve. See page 27.



Optional

Remote Start/Stop Connector. See page 22.

Drain. See page 14.

Quick Reference Operating Procedures





Installation

The unit has an air-cooled refrigeration system. Air is drawn in the front of the unit and discharged through rear and sides. Position the unit so the intake and discharge are not impeded. Inadequate ventilation will cause a reduction in cooling capacity and, in extreme cases, compressor failure.

Excessively dusty areas should be avoided and a periodic cleaning schedule should be instituted. For proper operation, the unit needs to pull substantial amounts of air through a condenser. A build up of dust or debris on the fins of the condenser will lead to a loss of cooling capacity.

The unit will retain its full rated capacity in ambient temperatures up to approximately +77°F (+25°C).

Make sure the voltage of the power source meets the specified voltage, ±10%.

The plumbing connections are located on the rear of the unit and are labelled  and . These connections are ½ inch FPT (¾ inch FPT for units with CP-55 pumps). Remove the plastic protective plugs from both plumbing connections. Connect the  fitting to the inlet of your application. Connect the  fitting to the outlet of your application.

To fill the reservoir, remove the reservoir access panel and locate the reservoir cap. Remove the cap and fill the reservoir with clean cooling fluid.

For fluid recommendations refer to page 14.



Operation

Before starting the unit, double-check all electrical and plumbing connections. Make sure the circulating system is properly filled with cooling fluid. Place the circuit breaker located on the rear of the unit to the up position.

To start the unit, press . To turn the unit off press  again.

The  LED indicates the status of the refrigeration system. It illuminates to indicate the refrigeration system is removing heat from the cooling fluid. As the operating temperature approaches the setpoint, the LED will flash.

Temperature Adjustment

To display the temperature setpoint, press  on the controller. The  indicator will illuminate and the display will flash the current setpoint value. To adjust the temperature setpoint, press the arrow keys until the desired temperature setpoint is indicated. Press  again to confirm the change. The display will rapidly flash the new value for a short time and then return to the recirculating fluid temperature.

Periodic Maintenance

Periodically inspect the reservoir fluid. If cleaning is necessary, flush the reservoir with a cleaning fluid compatible with the circulating system and the cooling fluid.

The cooling fluid should be replaced periodically. Frequency depends on the operating environment and amount of usage.

Before changing the cooling fluid ensure it is at a safe temperature.

Periodic vacuuming of the condenser fins is necessary. The frequency of cleaning depends on the operating environment. We recommend a monthly visual inspection of the condenser after initial installation. After several months, the cleaning frequency will be established.

Units with PD pumps have a strainer. If debris is in the system, the strainer will prevent the material from being drawn into the pump and damaging the pump vanes. A clogged strainer will also cause increased pump discharge pressure.

After initial installation, the strainer may become clogged.  **Clean the strainer after the first week of installation.** After this first cleaning, we recommend a monthly visual inspection. After several months, the cleaning frequency will be established. Before cleaning, disconnect the power cord from the power source and drain the unit.

Description

The Merlin Recirculating Chiller is designed to provide a continuous supply of cooling fluid at a constant temperature and volume. The unit consists of an air-cooled refrigeration system, plate heat exchanger, recirculating pump, polyethylene reservoir, and a microprocessor temperature controller.

Throughout the manual, you will be asked to consult the unit's serial number label for specific information. The label is located on the rear of the unit.

Specifications

	M-25	M-33	M-75	M-100	M-150
Temperature Range^{1,2}	+5°C to +35°C				
Temperature Stability^{1,3,4}	±0.1°C		±0.15°C		
Reservoir Volume					
<i>Gallons</i>	0.5				
<i>Liters</i>	1.9				
Refrigerant⁵	R134a			R404a	
Cooling Capacity (Watts)^{1,4}	<div style="display: flex; flex-direction: column; align-items: center;"> <div style="margin-top: 10px;"> <p>A = M-75 60Hz B = M-75 50Hz C = M-33 60Hz D = M-33 50Hz E = M-25 60 Hz F = M-25 50Hz</p> </div> <div style="margin-top: 10px;"> <p>A = M-150 60Hz B = M-150 50Hz C = M-100 60Hz, 50Hz</p> </div> </div>				

1. Specifications subject to change.
2. Modified temperature ranges to either -15°C or to +90°C are available.
3. At the chiller. Display resolution 1.0°C. 0.1°C display resolution is available using the controller's Setup/Tuning Loop, see page 20.
4. Circulating water at 20°C ambient. Cooling capacity will vary depending on fluid temperature, ambient temperature, and cooling fluid.
5. Standard temperature range units.

Pump Options

Standard temperature range units		
Unit	Standard	Optional
M-25	MD-30 or PD-1	None
M-33	MD-30 or PD-1	PD-2
M-75	PD-1	PD-2
M-100	PD-2	CP-55
M-150	PD-2	CP-55

High/Low temperature range units		
Unit	Standard	Optional
M-25	PD-1	None
M-33	PD-1	PD-2
M-75	PD-2	None
M-100	PD-2	CP-55
M-150	PD-2	CP-55

Pump Capacity

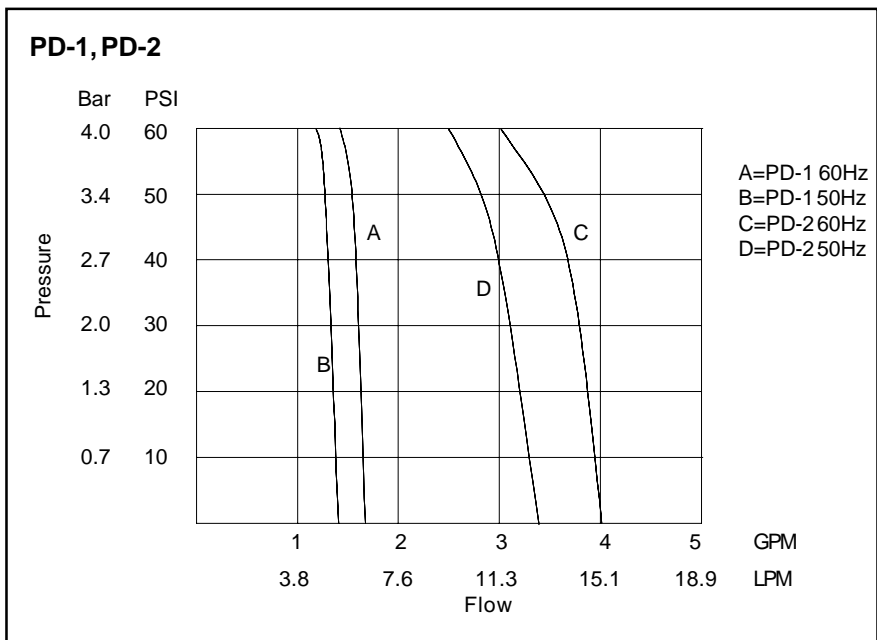

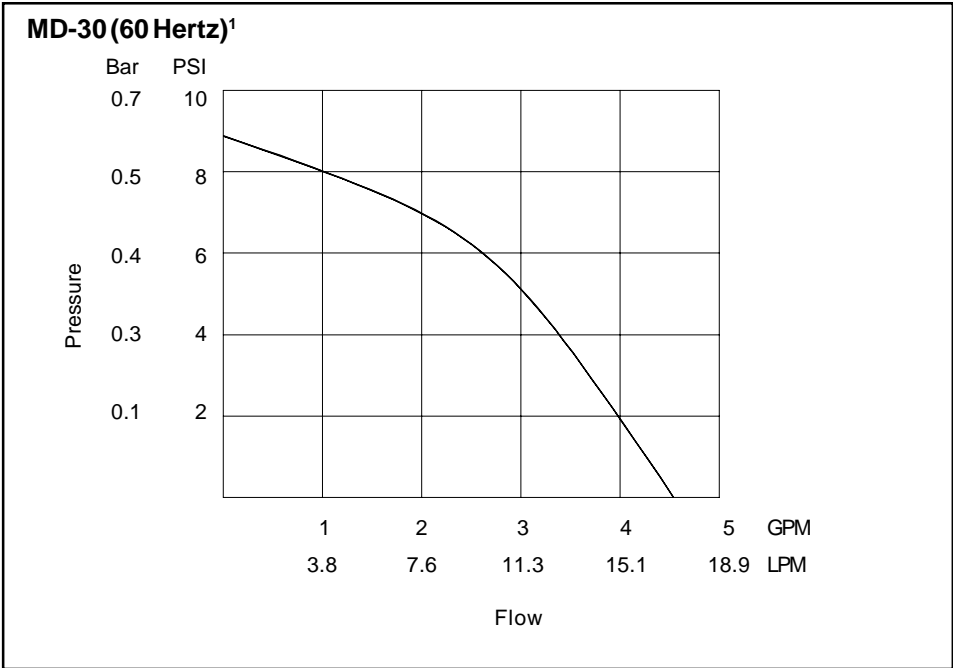

1. The MD-30 is not available for 50 Hertz units.

Unit Dimensions

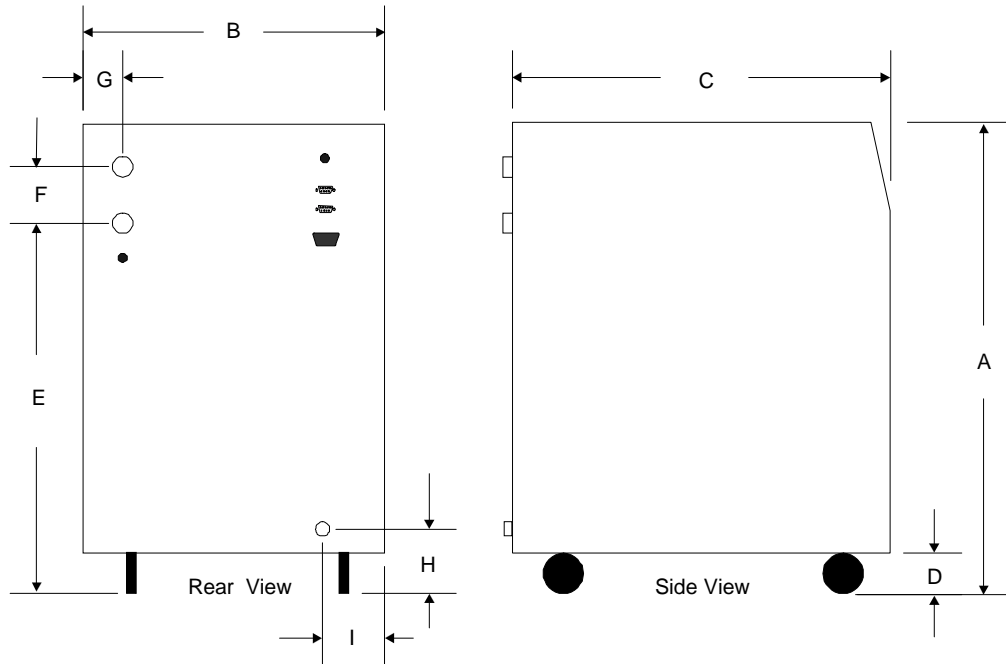

Unit Dimensions	M-25	M-33	M-75	M-100	M-150
Dimension A ¹	23 7/8	23 7/8	26 5/8	30 1/4	30 1/4
Dimension B ¹	12 5/8	12 5/8	16 1/4	21 1/4	21 1/4
Dimension C ¹	20 1/8	20 1/8	23 3/8	28 5/8	28 5/8
Dimension D ²	2	2	2	3	3
Dimension E ³	18 7/8	18 7/8	21 1/8	24 3/4	24 3/4
Dimension F ⁴	3	3	3	3	3
Dimension G ⁵	3/4	3/4	2	1 1/2	1 1/2
Dimension H ⁶	4	4	3	7 3/4	7 3/4
Dimension I ⁷	4 1/4	4 1/4	3 1/2	5	5
Crate Dimensions (D x W x H) ⁸	26x18 1/2x36	26x18 1/2x36	29 1/4x22 1/4x39	35 1/4x27x42	35 1/4x27x42
Shipping Weight ⁹	150	150	200	290	290
Air Intake (ft ³ /min) ¹⁰	178	178	385	755	755

1. Dimension A is the height of the unit. Units with CP-55 pumps are 6" higher. The unit width and depth (dimensions B and C) are the case dimensions, add approximately 1/2 inch to include the plumbing connections.
2. Dimension D is the distance from the floor to the bottom of the unit case (height of the casters).
3. Dimension E is the distance from the floor to the center of the outlet connection.
4. Dimension F is the distance between the center of the outlet and inlet connections.
5. Dimension G is the distance from the unit's side to the center of the outlet and inlet connections.
6. Dimension H is the distance from the floor to the center of the drain connection.
7. Dimension I is the distance from the unit's side to the center of the drain connection.
8. Crate dimensions for units with CP-55 pumps are 6 inches higher. All packages tested to ISTA 2B.
9. Shipping weight in pounds, ±10 pounds.
10. Air intake for 60 Hz units.

Section III Installation and Operation

Site

The unit should be located in a clean environment where ambient temperatures are inside the range of 10°C to 35°C (50°F to 94°F).



Never place the unit in a location where excessive heat, moisture, or corrosive materials are present.

The unit has an air-cooled refrigeration system. Air is drawn through the front of the unit and discharged through rear and side panels. The unit must be positioned so the intake and discharge are not impeded. A minimum clearance of 3 feet (1 meter) on all vented sides is necessary for adequate ventilation. Inadequate ventilation will cause a reduction in cooling capacity and, in extreme cases, compressor failure.

Excessively dusty areas should be avoided and a periodic cleaning schedule should be instituted (see Section IV, Maintenance and Service). Optional air filters are available, contact our Service Department. See Preface, After-Sale Support.

The unit will retain its full rated capacity in ambient temperatures up to approximately 25°C (77°F). Reduce the cooling capacity 1% for every 0.5°C (1°F) above 25°C (77°F), up to a maximum ambient temperature of 35°C (94°F).

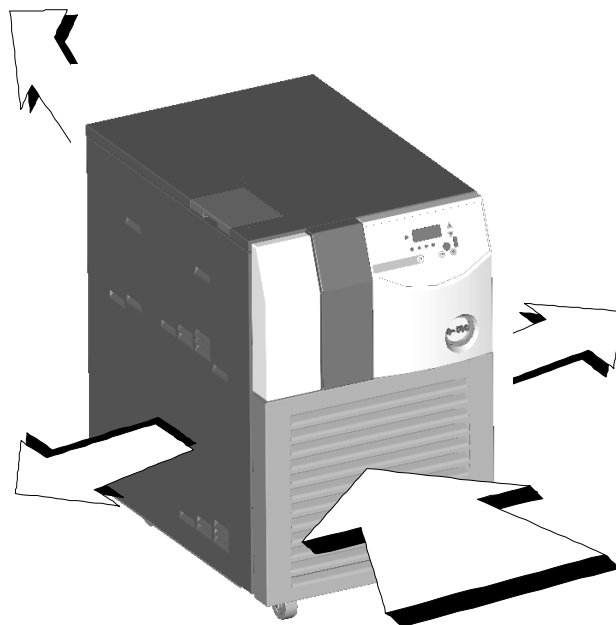

Direction of Air Flow

Electrical Requirements



The unit construction provides extra protection against the risk of electrical shock by grounding appropriate metal parts. The extra protection may not function unless the power cord is connected to a properly grounded outlet. It is the user's responsibility to assure a proper ground connection is provided.



The following power options are available:

Unit	Voltage	Frequency	Phase	Circuit Capacity
M-25	115	60	1	11
	100	50	1	10
	230	50	1	6
M-33	115	60	1	15
	100	50	1	14
	200-230	60	1	7
	200	50	1	8
	230	50	1	8
M-75	200-230	60	1	12
	200	50	1	10
	230	50	1	10
M-100	200-230	60	1	17
	200	50	1	16
	400	50	3/5W	6
M-150	200-230	60	1	20
	200	50	1	19
	400	50	3/5W	7



Amperage based on extreme operating conditions. Operating in a 20°C ambient and at nominal voltage will result in a lower amperage draw.

Refer to the serial number label on the rear of the unit for specific electrical requirements.

Plumbing Requirements

The plumbing connections are located on the rear of the unit and are labelled  and . The connections are 1/2 inch Female Pipe Thread. For units with CP-55 pumps, the connections are 3/4 inch Female Pipe Thread. Units with 1/2 inch fittings are supplied with 3/8 inch and 1/2 inch barbed adapters, units with 3/4 inch fittings are supplied with 1/2 inch and 3/4 inch barbed adapters.

Remove the plastic protective plugs from both plumbing connections. Install the barbed adapters to these connections.

Connect the  fitting to the hose feeding the inlet of your application. Connect the  fitting to the hose from the outlet of your application. Clamp all connections.



Never connect the fittings to your building water supply or any water pressure source.

NOTE: On units equipped with PD pumps, ensure your plumbing is rated to withstand 85 psi at the highest operating temperature.

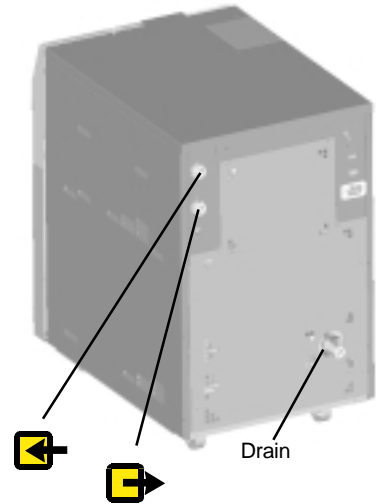

It is important to keep the distance between the unit and the instrument being cooled as short as possible. Tubing should be straight and without bends. If diameter reductions must be made, they should be made at the inlet and outlet of your application, not at the chiller.

All units have a ball-valve reservoir drain located on the rear of the unit. Add the desired length of tubing to the drain valve. To help prevent any spillage from your application, consider installing external isolation valves on the supply and return lines.

Fluids



Never use flammable or corrosive fluids with this unit. Do not use automotive antifreeze. Commercial antifreeze contains silicates that can damage the pump seals. Use of automotive antifreeze will void the manufacturer's warranty.

Acceptable fluids and their normal operating temperature ranges are:

- Filtered/Single Distilled water, +5°C to +85°C
- 50/50 Uninhibited Ethylene Glycol/Water, -15°C to +60°C
- 50/50 Inhibited Ethylene Glycol/Water, -15°C to +90°C
- 50/50 Uninhibited Propylene Glycol/Water, -15°C to +60°C
- 50/50 Inhibited Propylene Glycol/Water, -15°C to +90°C
- Deionized water (1 - 3 megohm, compensated), +5°C to +85°C

Refer to Appendix A, Water Quality and Standards, for additional information.

Filling Requirements

The polyethylene reservoir is translucent for easy fluid level monitoring. Remove the reservoir access panel. Locate and remove the reservoir cap. Fill the reservoir with clean cooling fluid, see previous page.

Since the reservoir capacity may be small compared to your application, have extra cooling fluid on hand to keep the system topped off when external circulation is started.

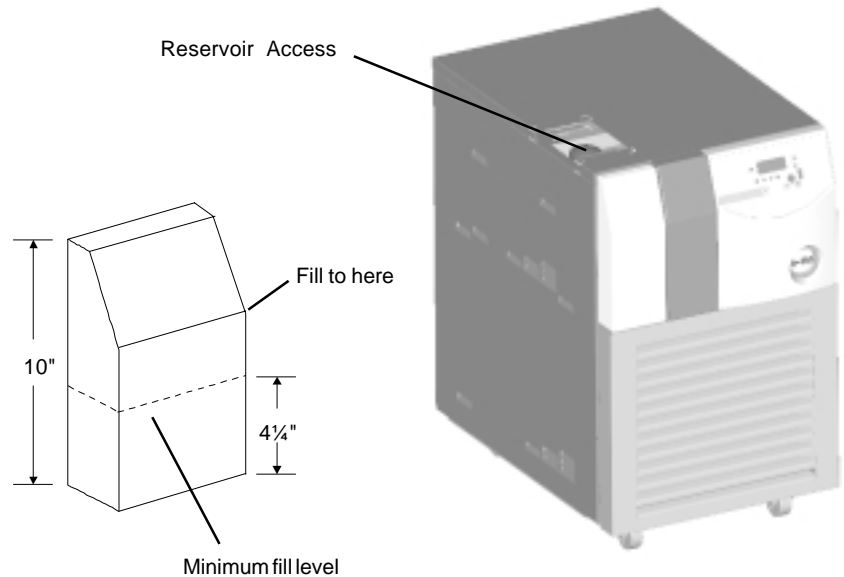

Reservoir Tank Isolation Valves

Units are equipped with two reservoir isolation valves. The valves are used to isolate the tank from the fluid flow to enable circulation to an open system or tank.

The units are factory shipped with the valves open for normal operation. If your application requires the process fluid to flow to an open tank above the unit, close the valves to prevent fluid siphoning and reservoir overflow. To close the valves you must remove the top and side access panels.

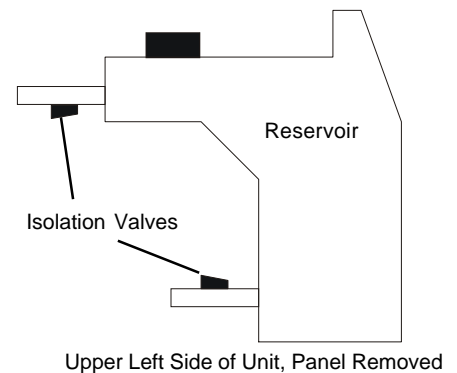

Ensure the valves are open when circulating to a closed system.



System temperature changes with the isolation valves closed, and while circulating to a closed system, can create a vacuum and/or high pressure conditions.

Controller

The controller controls temperature using a Proportional-Integral-Derivative (PID) algorithm. It is designed with self-diagnostic features and easy to use operator interface.

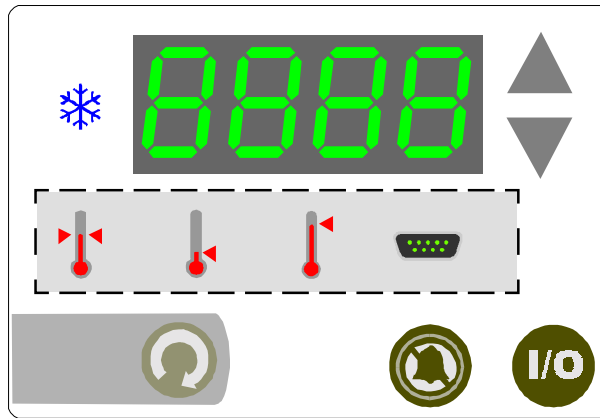

Controller



Use this key to toggle the **unit on or off**.



Use this key to **scroll** through the controller's LEDs. It is also used to accept and save changes.



If the alarm sounds, use this key to toggle the **alarm off and on**.

NOTE: If the cause of the alarm is cleared but then reoccurs, the alarm will sound again.



Use this key to **increment numerical values** when setting values.



Use this key to **decrement numerical values** when setting values.



Indicates **refrigeration system status**. It illuminates to indicate the refrigeration system is removing heat from the cooling fluid. As the operating temperature approaches the temperature setpoint, the LED will flash. The indicator is off when heat is not being removed.



NOTE: The following indications are not visible until  is depressed.





Indicates the controller is displaying the **setpoint**. Adjust the display value using the arrow keys. If neither arrow key is pressed within 10 seconds the display will return to the recirculating temperature display. Save the change using .

NOTE: You cannot adjust the setpoint closer than 2°C to either of the temperature limits discussed below. If  is not pressed for 60 seconds the display will return to the recirculating temperature display and ignore any changes.





Indicates the controller is displaying the **low temperature alarm** setting. The indicator flashes and the alarm sounds if this limit is exceeded. Adjust the display value using the arrow keys. If neither arrow key is pressed within 10 seconds the display will return to the recirculating temperature display. Save the change using . If  is not pressed for 60 seconds the display will return to the recirculating temperature display and ignore any changes.



Indicates the controller is displaying the **high temperature alarm** setting. The indicator flashes and the alarm sounds if this limit is exceeded. Adjust the display value using the arrow keys. If neither arrow key is pressed within 10 seconds the display will return to the recirculating temperature display. Save the change using . If  is not pressed for 60 seconds the display will return to the recirculating temperature display and ignore any changes.



(Optional) Indicates the unit is in the **remote/serial communication** mode of operation. The indicator flashes if the unit is in the remote start/stop mode of operation. Toggle between the local and remote modes using the arrow keys. If neither arrow key is pressed within 10 seconds the display will return to the recirculating temperature display. Save the change using .

If  is not pressed for 60 seconds the display will return to the recirculating temperature display and ignore any change.

Start Up/Shut Down

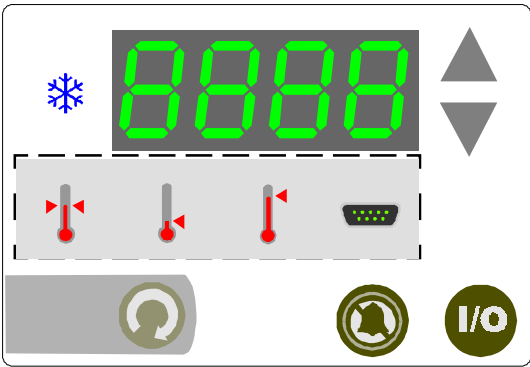

Controller

Pre-Start Before starting the unit, double check all electrical and plumbing connections. Have extra recirculating fluid on hand.



Circuit Breaker Place the circuit breaker located on the rear of the unit to the up position, the controller will flash and the alarm will momentarily sound.



The unit has automatic restart. If the unit was shutdown as a result of a power failure and power is restored, it will restart. If it was shut down using the circuit breaker, placing the circuit breaker up will restart the unit.

Starting Press . The controller will do a self-test (the controller will quickly sequence through its LEDs and momentarily sound the alarm) and then display the recirculating fluid temperature. The refrigeration system and the recirculation pump will then start. The RECIRCULATING PRESSURE gauge will display the pump operating pressure. If the pressure needs adjusting, refer to page 26.

NOTE: If on start up the unit's recirculating fluid is outside either temperature limit, the unit will operate but the appropriate indicator will flash until the fluid is within the limit.



Setpoint To display/change the setpoint press  until  illuminates. The display will flash the current setpoint value. Use the arrow keys to change the value.

NOTE: If the arrow keys are not pressed within 10 seconds the display will return to the current reservoir temperature. The controller will not allow you to enter a setpoint closer than 2°C of either temperature alarm setting discussed on the next page. Trying to use a setpoint within 2°C causes the appropriate indicator to flash and sounds the audible alarm twice.

Once the desired setpoint is displayed, press  again to confirm the change. The display will rapidly flash the new value for a short period and then return to the recirculating fluid temperature.

NOTE: If the new value is not confirmed within 60 seconds the display will return to the recirculating fluid temperature and ignore any changes.

Low Temp Alarm



To display/change the low temperature alarm setting press  until  illuminates. The display will flash the current limit value. Use the arrow keys to change the value. The range is 0°C (-15°C for low-temp units) to 30°C.

NOTE: If the arrow keys are not pressed within 10 seconds the display will return to the current reservoir temperature.

Once the desired setting is displayed, press  again to confirm the change. The display will rapidly flash the new value for a short period and then return to the recirculating fluid temperature. See Error Codes on page 24.

NOTE: If the new value is not confirmed within 60 seconds the display will return to the recirculating fluid temperature and ignore any changes.

High Temp Alarm



To display/change the high temperature alarm setting press  until  illuminates. The display will flash the current setting value. Use the arrow keys to change the value. The range is 10°C to 40°C (90°C for high-temp units).

NOTE: If the arrow keys are not pressed within 10 seconds the display will return to the current reservoir temperature.

Once the desired limit is displayed, press  again to confirm the change. The display will rapidly flash the new value for a short period and then return to the recirculating fluid temperature. See Error Codes on page 24.

NOTE: If the new value is not confirmed within 60 seconds the display will return to the recirculating fluid temperature and ignore any changes.

Remote/Serial Comm

(Optional) To enable or disable remote/serial communication press  until  illuminates. The display will flash the communication status. Use the up arrow key to enable, the down arrow to disable.

NOTE: If the arrow keys are not pressed within 10 seconds the display will return to the current reservoir temperature.

Once the desired status is displayed, press  again to confirm the change. The display will rapidly flash the new status for a short period and then return to the recirculating fluid temperature.

NOTE: If the new status is not confirmed within 60 seconds the display will return to the recirculating fluid temperature and ignore any change.

NOTE: Enabling serial communications disables the remote start/stop feature, see page 22. In either mode, the setpoint and alarm values can not be changed using the controller but they can still be viewed.

Stopping

To turn the unit off, press .

Setup/Tuning Loop

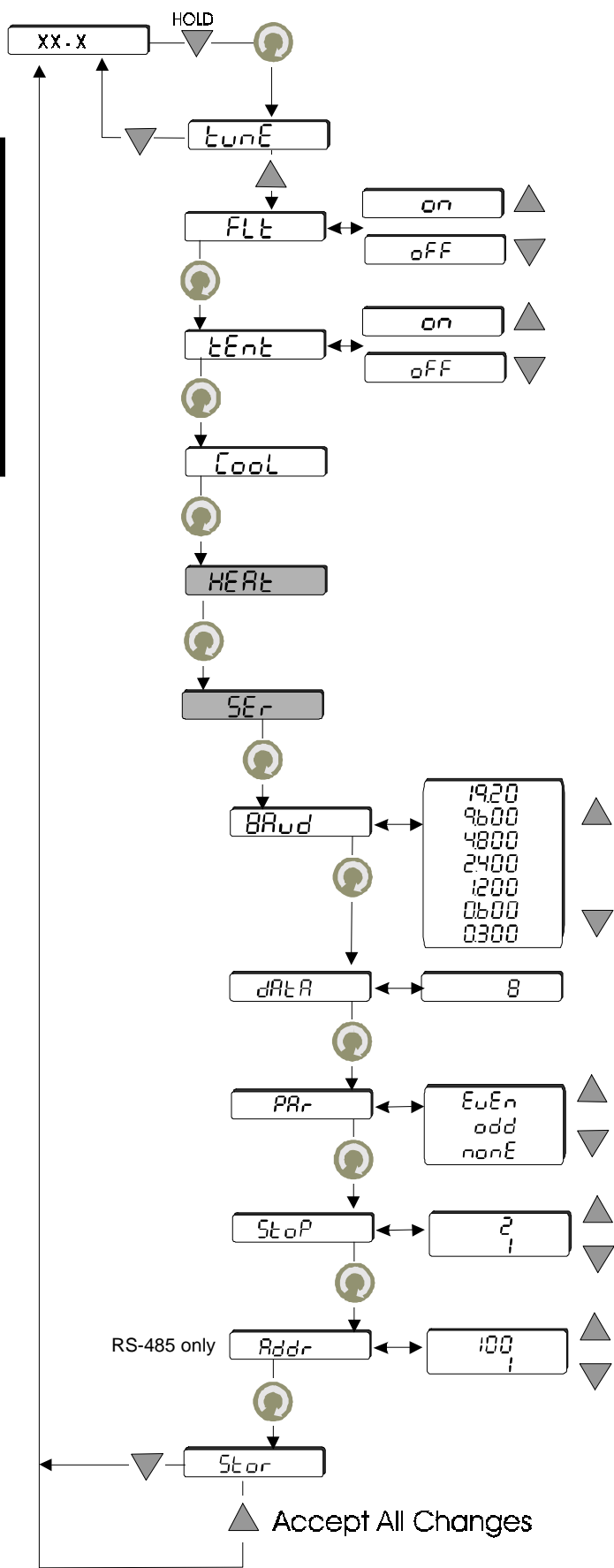

The Setup/Tuning Loop is used to configure the controller temperature display and various operating parameters. To enter the loop you must be displaying the reservoir fluid temperature and then, while pressing and holding ▼, press ⏸.

The display will indicate tunE. Use the arrow keys to enter/bypass the loop. Once in the loop press ⏸ to sequence through it. Use the arrow keys to change any display.

The loop is used to determine how the unit will react when a fault occurs (FLt) — either shut down (on) or continue to run (off). The unit is shipped configured to run.

It is also used to configure the temperature displays to indicate to a tenth of a degree (tEnt).

The loop can also be used to set the controller's PID parameters (COOL HEAT). The Thermo NESLAB factory preset values are:

COOL	P	I	D
STDTEMPUNITS	20	0.5	0.0
LOWTEMPUNITS	12	0.5	0.0
HIGHTEMPUNITS	7	0.5	0.0
HEAT			
ALL UNITS	5	0.5	0.0

Thermo NESLAB recommends that only a qualified technician change PID parameters. Incorrect PID values will hamper unit performance.

The heat PID is only applicable to units configured with a heater.

The loop is also used to adjust/verify serial communication parameters (SEr). This section of the loop is applicable only to units configured for serial communications capability.

Changes made in the Tuning/Setup Loop take effect when ▲ is pressed at the Stor prompt. Pressing ▼ at the prompt aborts all changes.

Section IV Options

Communication Connector



A female 9-pin D-connector is located on the rear of the unit. The connector is used for either RS-232 or RS-485 serial communication (see Appendix B or C).

When the unit is controlled via serial communication the  LED on the controller is illuminated.

When the unit is configured for serial communication the unit cannot be started using the local controller. However, the unit can be stopped using the local controller. To restart, send another start command.

Options

RS-232 (J-102) COMM Pin Connection

Pin #	Function
1	No connection
2	TX = Transmitted data from controller
3	RX = Received data to controller
4	No connection
5	GND = Signal ground
6	No connection
7	No connection
8	No connection
9	No connection

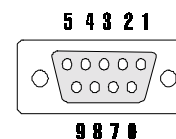

Hardware Mating Connector
AMP Part# 745492-2 or equivalent

RS-485 (J-103) COMM Pin Connections

Pin #	Function
1	No connection
2	No connection
3	No connection
4	No connection
5	No connection
6	No connection
7	No connection
8	TX = Transmitted data from controller
9	RX = Received data to controller

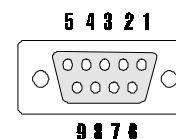



Hardware Mating Connector
AMP Part# 745492-2 or equivalent

Remote Start/Stop



A male 9-pin D-connector is located on the rear of the unit. The connector is used for either 12 - 24VAC or 12 - 24VDC remote start/stop; and as a status relay dry contact.

To start the unit from a remote location apply the correct voltage to J101, pins 4 & 5. When the unit is started by a remote start/stop voltage  on the controller will flash.

Once started remotely, stop the unit by removing the applied voltage from J101 or by pressing  on the local controller. To restart remotely after stopping locally remove and reapply the remote start voltage to J101.

NOTES:

Enabling serial communications disables the remote start/stop feature.

Should the unit experience a high/low temperature warning/fault, a reservoir level warning/fault, or a low pump flow warning/fault, the status relay will de-energize.

(J-101) COMM Pin Connection

Pin #	Function
1	Status, NO
2	Status, NC
3	Status, Common
4	Remote On +
5	Remote On -
6	No Connection
7	No Connection
8	No connection
9	No connection

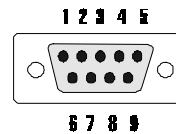

Hardware **Mating Connector**
AMP Part# 745491-2 or equivalent

Remote Start Input:

12 to 24 Volts DC $\pm 10\%$ maximum input current, 9ma.

12 to 24 Volts AC $\pm 10\%$ maximum input current, 5ma.

Absolute maximum input voltages:

40 volts rms. continuous.

56 volts peak.

Reservoir Level Warning/Fault

NOTE: This is a standard feature for high-temperature units.

Should the reservoir fluid level drop below normal the mutable alarm will sound, the status relay will de-energize, an error message will be displayed, and, depending on the unit's configuration, the unit will continue to run or shut down. Refill the reservoir and, if necessary, restart the unit.

The unit will not start without any fluid in the reservoir regardless of how it is configured.

The unit is configured to run or shut down using the controller's Setup/Tuning Loop on page 20.

Low Pump Flow Warning/Fault

NOTE: This is a standard feature for high-temperature units.

Should the pump flow drop below 0.25 gpm (1.0 gpm for units with a CP-55 pump) the mutable alarm will sound, the status relay will de-energize, an error message will be displayed, and, depending on the unit's configuration, the unit will continue to run or shut down.

Once the cause of the low flow is identified and corrected restart the unit, if necessary.

The unit is configured to run or shut down using the controller's Setup/Tuning Loop, see page 20

Additional Accessories

External Filtration Package

A partial flow liquid filter available in 5, 10, 25, and 40 micron filter sizes.

External DEI Package

Partial flow DEI package will maintain between 1 and 3 megohm/cm² water resistivity. A cartridge indicator lets you know when the filter needs changing.



Condenser Air Filter

An easy to install air filter protects the condenser in dusty environments.

Section V Maintenance and Service

Error Codes

On Start Up:

- Er 00* ROM ckecksum. Clear with  key.
- Er 01* Test failure. Locks up the program.
- Er 02* Display board failure. Clears when display board is fixed.
- Er 03* Critical checksum failure. Clear with  key.
- Er 14* Synchronous comm
- Er 15* Asynchronous comm
- Er 1b* Bad calibration data

Unusual Hardware Conditions

These errors will flash on the display and cannot be cleared. These are internal controller problems.

- Er 04* through *Er 13* - Interrupt errors during runtime.
- ConF* BOM invalid

Functional/ Machine errors







These are the runtime/logic errors. These errors will clear themselves once the problem disappears.

Error Display	Indication
<i>Lot</i>	Low temp setpoint warning/fault
<i>Add</i>	Low level warning, fluid below minimum fill level, see page 15
<i>H it</i>	High temp setpoint warning/fault
<i>Er 25</i>	Shorted RTD1
<i>Er 2b</i>	Open RTD1
<i>LoFL</i>	Low process flow warning/fault
<i>LLF</i>	Fluid low level fault - unit shuts down
<i>Er 50</i>	Low flow to heat exchanger fault - unit shuts down

Unit reaction to warning/fault errors depend on how the unit is configured, see Setup/Tuning Loop on page 20. The unit is shipped configured to continue running. If any other code appears contact Thermo NESLAB customer service.

Displaying Software Version Number

The controller can display the installed software version number. For example, for a unit with software version **026950.1A**:

1. Unit is running normally and displaying recirculating fluid temperature.
2. Press and hold  for at least 10 seconds. The display will show the first two digits, for example: *02* .
3. Press 
The display will show the remaining digits to the left of the decimal, for example: *6950*.
4. Press 
The display will show the decimal point and the digit to the right of the decimal point, for example, *.1* .
5. Press 
The display will show the revision letter, as its equivalent number, for example, *1* = A.
6. Press 
Disregard this display.
7. Press 
The display returns to the recirculating fluid temperature.

Cleaning

Reservoir

Periodically inspect the fluid inside the reservoir. If cleaning is necessary, flush the reservoir with a cleaning fluid compatible with the circulating system and the cooling fluid.

The cooling fluid should be replaced periodically. Replacement frequency depends on the operating environment and amount of usage.



Before changing the cooling fluid ensure it is at a safe handling temperature.

NOTE: It will be necessary to use a wet-vac or siphon to completely drain the reservoir. Use care so as not to damage the reservoir float switch.

See page 15, Filling Requirements, for instructions on cooling fluid replacement.

Condenser

For proper operation, the unit needs to pull substantial amounts of air through a condenser. A build up of dust or debris on the fins of the condenser will lead to a loss of cooling capacity. Optional air filters are available, contact our Service Department. See Preface, After-Sale Support.

The lower front of the unit has a one-piece grille assembly. Using your hands gently pry the assembly off. Use care not to scratch the paint.

Periodic vacuuming of the condenser fins is necessary. The cleaning frequency depends on the operating environment. After initial installation we recommend a monthly visual inspection of the condenser. After several months, the cleaning frequency will be established.



Use care cleaning the condenser fins, they can easily bend.

Algae

To restrict the growth of algae in the reservoir, it is recommended that the reservoir cover be kept in place and that all circulation lines be opaque. This will eliminate the entrance of light which is required for the growth of most common algae.

ThermoNESLAB recommends the use of Chloramine-T, 1 gram per 3.5 liters. Other algicides can be harmful to the unit's internal components. Contact Thermo NESLAB for additional information.

Leaks

A very small leak between the pump and motor is normal. If this is a new pump, allow it to run for 24 hours and reinspect. A continuous leak will require pump replacement.

PD Pressure Relief Valve



Units with PD pumps have a Pressure Relief Valve. The valve is used to adjust the unit's fluid flow/pressure.

NOTE: The valve is factory preset for the most common applications and normally requires no further adjustment. Also, the unit's pump is factory preset not to exceed 80 ± 5 psi (550 ± 1 kPa).

Before adjusting the valve turn the unit off. Locate the circular relief valve opening on the rear of the unit.

Turn the threaded stem fully clockwise.

If the unit is not plumbed to an application, install a loop of hose equipped with a shut-off valve between the supply and return fittings.

Turn the unit on.

Use the pressure gauge to read the relief valve setting.

Back out the threaded stem on the relief valve counterclockwise. Continue until the gauge indicates 80 psi (550 kPa) or the desired setting.

NOTE: The relief valve may drip if the threaded stem is backed out too far.

PD Pump Strainer

Units with PD pumps have a strainer. Refer to the serial tag label on the rear of the unit and the BOM decoder on page 29 to identify the type of pump.

If debris is in the system, the strainer will prevent the material from being drawn into the pump and damaging the pump vanes. A clogged strainer will also cause increased discharge pump pressures.



After initial installation, the strainer may become clogged with debris and scale. Therefore, **the strainer must be cleaned after the first week of installation**. After this first cleaning, we recommend a monthly visual inspection. After several months, the cleaning frequency will be established.



Before cleaning the strainer ensure the cooling fluid it is at a safe handling temperature. Disconnect the power cord from the power source and drain the unit.

PD pumps have a strainer located in the pump suction line. The strainer is located behind the right-side panel.

Remove the panel from the unit. Use one wrench to support the filter housing, and a second wrench to unscrew the 1 ¼ inch fitting. Remove the screen.

Clean the screen by rinsing it with water. When the screen is clean, replace it in the strainer, tighten the fitting and replace the panel. Refer to Section III for instructions on replacing the cooling fluid.

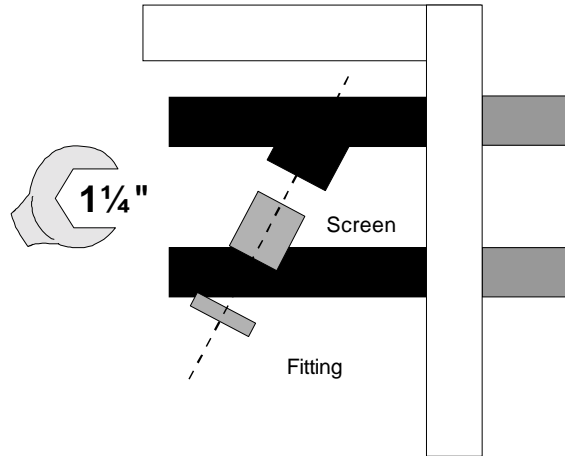

Right-side view

PD Pump Motor Lubrication

Some PD pumps use sleeve type bearings with large reservoirs. Oiling instructions are generally posted on each motor. In the absence of instructions, add approximately 30 to 35 drops of SAE 20 non-detergent oil to each bearing on the following schedule (SAE 20 = 142 CS viscosity):

Duty Cycle	Oiling Frequency
Continuous	Once every year
Intermittent	Once every 2 years
Occasional	Once every 5 years

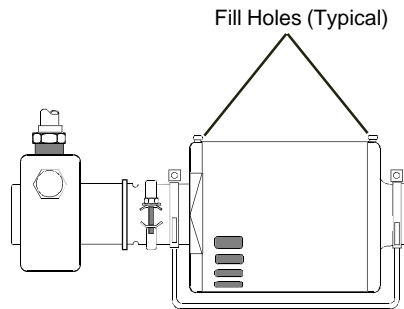

BOM Decoder

The Bill of Material (BOM) number helps identify the configuration of your unit. The number is printed on the label located on the rear of the unit.

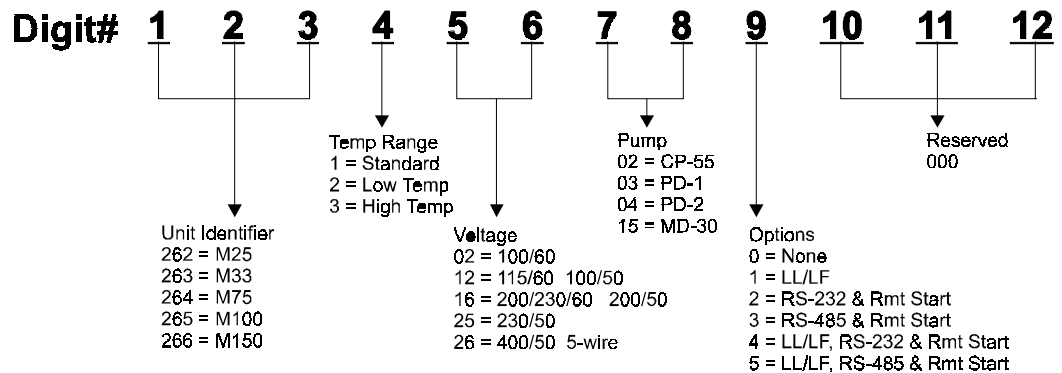

Section VI Troubleshooting

Checklist

Unit will not start

Check the line cord; ensure it is plugged in.

Check the position of the circuit breaker on the rear of the unit.

Check the controller for error codes, see page 24.



NOTE: On units with a Low Flow Switch and configured to shut down with a low flow fault (L_oF_L), several starting attempts may be necessary.

On units with a Reservoir Level Switch check the reservoir level.

Optional serial communications or remote start/stop enabled.

Make sure power source voltage is within the unit rated voltage $\pm 10\%$.

400 Volt, 50 Hertz units are equipped with a phase monitor. Ensure proper phase to the unit.

If  is lit, the unit was shut off using serial communications. Start the unit using serial communications. To start the unit using the local controller press and hold both arrow keys for 10 seconds, the controller will power. Turn serial communications off using the procedure on page 17, and then press  to turn off the controller. Press  again to start the unit.

Unit will not circulate fluid

Check the reservoir level. Fill, if necessary.

Check the position of the reservoir tank valves. See Reservoir Tank Valves.

Check the instrument being cooled for restrictions in the cooling line.

Check the pump strainer (units with PD pumps).

The pump motor may be too hot. Allow it to cool.

Check the pressure gauge, adjust the relief valve as necessary (units with PD pumps).

Inadequate temperature control

Verify the setpoint.

If the temperature continues to rise, make sure your application's heat load does not exceed the rated specification, see Section II, Specifications.

Make sure the air intake and discharge are not impeded and the ambient temperature does not exceed $+35^{\circ}\text{C}$.

Make sure the condenser is free of dust and debris, see Section V, Maintenance and Cleaning.

Verify the controller's PID values, see Setup/Tuning Loop.

No serial communications (optional)

All units are tested for serial communications before they leave the factory. Check the controller, ensure serial communication is enabled.

Check all communications commands, they *must be exact*. See Appendix B or C.

Check all wiring for proper connections or possible shorts.

Software to verify serial communication is available from Thermo NESLAB.

Service Assistance

If, after following these troubleshooting steps, your unit fails to operate properly, contact our Service Department for assistance (see Preface, After-sale Support). Before calling, *please* obtain the following information:

- *unit BOM number*
- *unit serial number*
- *software version*
- *voltage of power source*

Appendix A Water Quality Standard and Recommendations

	Permissible (PPM)	Desirable (PPM)
Microbiologicals		
(algae, bacteria, fungi)	0	0
Inorganic Chemicals		
Calcium	<40	0.6
Chloride	250	<25
Copper	1.3	1.0
Iron	0.3	<0.1
Lead	0.015	0
Magnesium	<12	0.1
Manganese	0.05	<0.03
Nitrates/Nitrites	10 as N	0
Potassium	<20	0.3
Silicate	25	<1.0
Sodium	<20	0.3
Sulfate	250	<50
Hardness	17	<0.05
Total Dissolved Solids	50	10
Other Parameters		
pH	6.5-8.5	7-8
Resistivity	0.01*	0.05-0.1*
* Megohm-Cm (Compensated to 25°C)		

Unfavorably high total ionized solids (TIS) can accelerate the rate of galvanic corrosion. These contaminants can function as electrolytes which increase the potential for galvanic cell corrosion and lead to localized corrosion such as pitting which can be observed at the studs and on the outside surface of cooling coils. Eventually, the pitting will become so extensive that the coil will leak refrigerant into the water reservoir.

For example, raw water in the U.S. averages 171 ppm (of NaCl). The recommended level for use in a water system is between 0.5 to 5.0 ppm (of NaCl).

Recommendation: Initially fill the tank with distilled/deionized water. Do not use untreated tap water as the total ionized solids level may be too high.

Maintain this water quality at a resistivity of between 1 to 10 megohm-cm (compensated to 25°C) by using a purification system. Although the initial fill may be as high as 10 megohm-cm (compensated to 25°C), the desired level for long time usage is 1 to 3 megohm-cm (compensated to 25°C).

The above two recommendations will reduce the electrolytic potential of the water and prevent or reduce the galvanic corrosion observed.

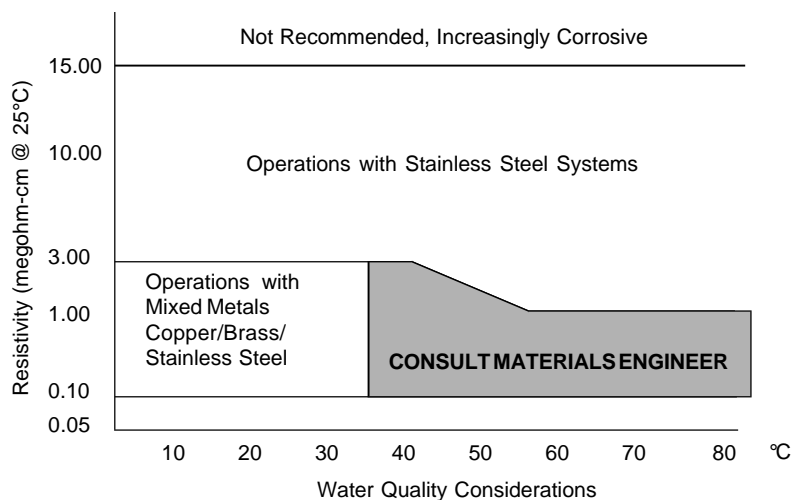

Merlin Compatibility with Recommended Fluids

Filtered/Singled Distilled water, +5°C to +85°C

This fluid is recommended primarily because it has all microorganisms that cause biological fouling removed through vaporizing and condensing the water. However, distilled water does not remain pure for very long when exposed to the atmosphere. Air-born spores can contaminate the water and activate alga growth. Chloramine-T is a compatible algaecide that can be used to combat growth but a more effective maintenance plan would include switching out the fluid with newly distilled water every six month. The particulates that have been filtered out in the process are also preventative in keeping the system “clean” of contaminants. One thing to note is that distilling water that contains an additive could increase the concentration of that additive in the water.

50/50 Uninhibited Ethylene Glycol/Water (-15°C to + 60°C)

Ethylene glycol is used to depress the freezing point of water as a coolant. We are recommending to not use the inhibited (no corrosion additives) above 60°C because it breaks down into acidic by-products faster at high temperatures. These acidic by-products, especially carbonic acid, are corrosive to copper. The inhibitors are used to control the corrosion rates by passivating the metal surfaces with an inert film. Uninhibited ethylene is more corrosive to copper than plain water so therefor it should not be recommended unless it is required for the application.

50/50 Inhibited Ethylene Glycol/ Water (-15°C to +90°C)

Inhibited glycol can be used to increase the operating temperature range of the fluid but should not be used as a “pre-mixed anticorrosive” solution. Again, this fluid does break down over time at high temperatures. Dow uses a pH standard of 8 to base when the fluid has become corrosive. Dowtherm is an ethylene based product that contains dipotassium phosphates in a 4% concentration. The recommended use of Dowtherm is mixing with distilled or deionized water or water that contains less than 25 ppm chloride and sulfate and less than 100 ppm total hardness of CaCO₃. The general term, inhibited glycol/water, almost too close to meaning inhibited water. Inhibited water can have many types of additives including chromate that will foul our cooling system very quickly. Some inhibitor additives can release the bonding agent in the carbon graphite in the PD2 pumps and therefor are incompatible, such as Sodium Hydroxide.

50/50 Uninhibited Propylene Water (-15°C to + 60°C)

Although the use of this glycol similar to ethylene glycol, propylene glycol is considered “safe” to use in the food industry. Propylene is less dense than ethylene and therefor will have a tendency to weep more through mechanical seals.

50/50 Inhibited Propylene/ Water (-15°C to +90°C)

Same issues as with uninhibited propylene and inhibited ethylene glycol.

Deionized water (1-3 megohm, compensated, +5°C to 85°C)

This water has the ions controlled so that they will not conduct and cause galvanic corrosion between dissimilar metals. Deionized water is aggressive to metal when it is too pure since this is not the normal state of water. The leaching of metallic ions from the metal surface is seen in pitting.

NEVER use flammable or corrosive fluids with this unit. Do not use automotive anti-freeze. Commercial antifreeze contains silicates that can damage the pump seals. Use of automotive antifreeze will void the manufacturer’s warranty.

Wetted Materials

PD PUMPS (Part Number 008806- PD2, Part Number 008816-PD1):

Carbon Graphite (Graphitar Type B)
Brass
303 Stainless Steel
Ceramic (85% Aluminum Oxide and Balance is Considered Glass)
Fluorocarbon (Viton equivalent)
Ultem (relief Valve Material)

MD-30 (Part Number 026922):

Polypropylene
Ceramic
Magnet
Buna-N

CP-55 PUMP (Part Number 026652):

Stainless Steel
Viton

Evaporator

(Part Numbers 026964/026945/026880):

AISI 316 Stainless Steel
Copper Brazing

Tank Fittings:

Brass

Strainer (Part Number 009334):

Bronze
304 Stainless Steel Mesh

Tank Cap (Part Number 026992):

Nylon

Tank Body (Part Number 026933):

Polyethylene (LLPDE, Mobile NRP=135)

Hose Assemblies/Plumbing:

Buna-N (Parker Push-Lok O-ring)
Nitrile based synthetic rubber (Parker Push-Lok hoses) Part Number 026931
Brass Part Number 032688
Copper Part Number 003752

Ball Valve (Part Number 026981):

Viton
Chrome plated brass body and ball
PTFE

Sealants:

95/5 solder
Bcup5 Brazing
Anearobic Methacrylate Ester (Perma-Lok LM012) - 013002

Low Level/Low Flow Switches (Option1):

Polysulphone (Part Number 026900) Low Level
Brass (Part Number 026901) Low Flow

Appendix B RS-232 Serial Communications Protocol

NOTE: This appendix assumes you have a basic understanding of communications protocols.

All data is sent and received in binary form, do not use ASCII. In the following pages the binary data is represented in hexadecimal (hex) format.

The Thermo NESLAB Serial Communications Protocol, NC, is based on a master-slave model. The master is a host computer, while the slave is the chiller's controller. Only the master can initiate a communications transaction (half-duplex). The slave ends the transaction by responding to the master's query. The protocol uses an RS-232 serial interface with the default parameters: 9600 baud, 8 data bits, 1 stop bit, no parity and no handshaking.

NOTE: Before the unit will communicate, RS-232 must be turned on using the controller. Ensure the  indicator is illuminated.

The unit can be controlled through your computer's serial port by using the unit's standard 9-pin RS-232 connection. Data read of the serial port connects to the data transmit (pin 2) of the unit. Data transmit of the serial port connects to data read (pin 3) of the unit.

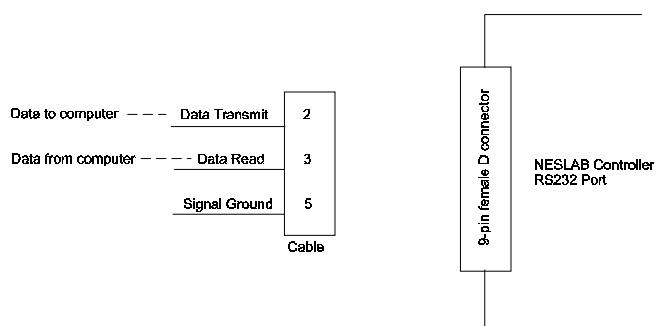

Communication cables are available from Thermo NESLAB. Contact our sales department for additional information.

All commands must be entered in the exact format shown in the tables on the following pages. The tables show all commands available, their format and responses. Controller responses are either the requested data or an error message. The controller response *must* be received before the host sends the next command.

The host sends a command embedded in a single communications packet, then waits for the controller's response. If the command is not understood or the checksums do not agree, the controller responds with an error command. Otherwise, the controller responds with the requested data. If the controller fails to respond within 1 second, the host should resend the command.

NC Serial Communications Protocol

NOTE: All byte values are shown in hex, hex represents the binary values that must be sent to the chiller. **Do not use ASCII.**

The framing of the communications packet in both directions is:

Checksum region								
Lead char CA	Addr-MSB 0	Addr-LSB 1	Command	n d-bytes	d-byte 1	...	d-byte n	Checksum

<i>Lead char</i>	CA (hex).
<i>Addr-msb</i>	Device address is 1
<i>Addr-lsb</i>	Most significant byte of device address is 0.
<i>Command</i>	Least significant byte of device address is 1.
<i>n d-bytes</i>	Command byte (see Table 1).
<i>d-byte 1</i>	Number of data bytes to follow (00 to 03 hex).
...	1 st data byte (the qualifier byte is considered a data byte).
<i>d-byte n</i>	...
<i>Checksum</i>	n th data byte.
	Bitwise inversion of the 1 byte sum of bytes beginning with the most significant address byte and ending with the byte preceding the checksum. (To perform a bitwise inversion, "exclusive OR" the one byte sum with FF hex.)

The master requests information by sending one of the Read Functions as shown in Table 1. Since no data is sent to the chiller during a read request, the master uses 00 for the number of data bytes following the command byte.

Appendix B The chiller will respond to a Read Function by echoing the lead character, address, and command byte, followed by the requested data and checksum. When the chiller sends data, a qualifier byte is sent first, followed by a two byte signed integer (16 bit, MSB sent first). The qualifier byte indicates the precision and units of measure for the requested data as detailed in Table 2.

As an example, the master requests to read internal temperature by sending:

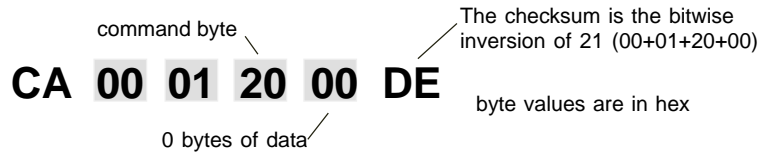

If the temperature is -12°C, the slave would reply:

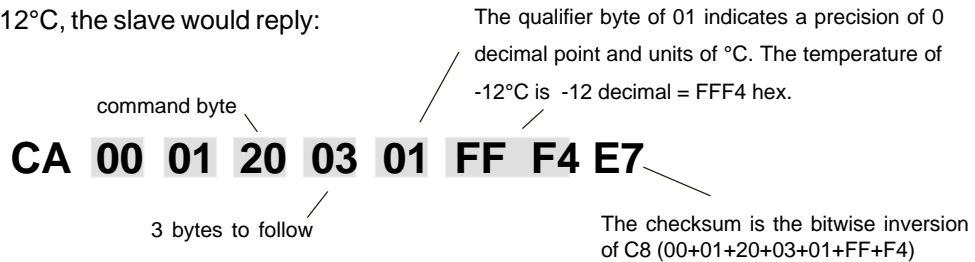

The master sets parameters in the chiller by sending one of the Set Functions as shown in Table 1. The master does not send a qualifier byte in the data field. The master should be preprogrammed to send the correct precision and units (it could also read the parameter of interest first to decode the correct precision and units needed).

For example, if the master wants to set the setpoint to 30°C, it would send :

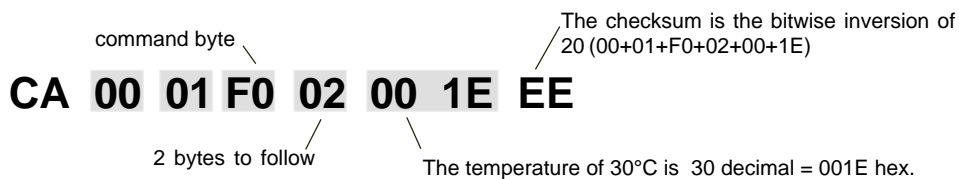

The slave responds:

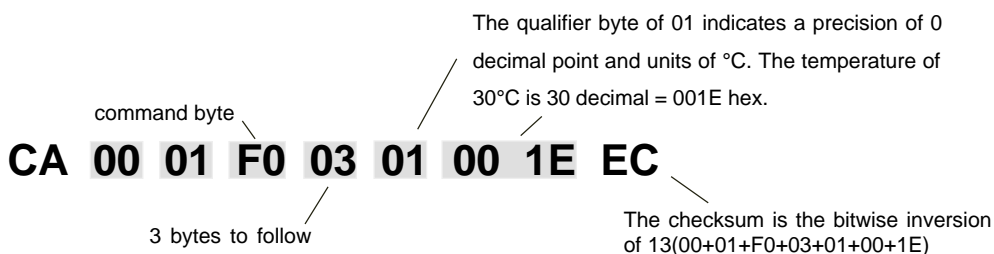

Table 1 Commands (All bytes are in hex)

FUNCTION	MASTER SENDS	UNIT RESPONDS
<u>READ</u>		
Read Acknowledge	CA 00 01 00 00 FE	CA 00 01 00 02 v1 v2 cs
Read Status*	CA 00 01 09 00 F5	CA 00 01 09 02 d1 d2 cs
Error		CA 00 01 0F 02 en ed cs
Read Internal Temperature	CA 00 01 20 00 DE	CA 00 01 20 03 qb d1 d2 cs
Read Setpoint (control point)	CA 00 01 70 00 8E	CA 00 01 70 03 qb d1 d2 cs
Read Low Temperature Limit	CA 00 01 40 00 BE	CA 00 01 40 03 qb d1 d2 cs
Read High Temperature Limit	CA 00 01 60 00 9E	CA 00 01 60 03 qb d1 d2 cs
Read Cool Proportional Band (P)	CA 00 01 74 00 8A	CA 00 01 74 03 qb d1 d2 cs
Read Cool Integral (I)	CA 00 01 75 00 89	CA 00 01 75 03 qb d1 d2 cs
Read Cool Derivative (D)	CA 00 01 76 00 88	CA 00 01 76 03 qb d1 d2 cs
Read Heat Proportional Band (P)	CA 00 01 71 00 8D	CA 00 01 71 03 qb d1 d2 cs
Read Heat Integral (I)	CA 00 01 72 00 8C	CA 00 01 72 03 qb d1 d2 cs
Read Heat Derivative (D)	CA 00 01 73 00 8B	CA 00 01 73 03 qb d1 d2 cs

command bytes shown in **bold**

qb = qualifier byte, see Table 2

d1,d2 = 16 bit signed integer of the value being sent or received

Bad data, 03: Bad checksum

cs = the checksum of the string (see text)

* See Read Status, see Table 3

v = protocol version

ed = error data

en = error number 01: Bad command, 02:

xx = no valid data, include in checksum

Table 1 Commands (continued) (All bytes are in hex)

FUNCTION	MASTER SENDS	UNIT RESPONDS
SET		
Set Setpoint (control point)*	CA 00 01 F0 02 d1 d2 cs	CA 00 01 F0 03 qb d1 d2 cs
Set Low Temp	CA 00 01 C0 02 d1 d2 cs	CA 00 01 C0 03 qb d1 d2 cs
Set High Temp	CA 00 01 E0 02 d1 d2 cs	CA 00 01 E0 03 qb d1 d2 cs
Set Cool Proportional Band (P=1-99.9)	CA 00 01 F4 02 d1 d2 cs	CA 00 01 F4 03 qb d1 d2 cs
Set Cool Integral (I = 0-9.99)	CA 00 01 F5 02 d1 d2 cs	CA 00 01 F5 03 qb d1 d2 cs
Set Cool Derivative (D= 0-5.0)	CA 00 01 F6 02 d1 d2 cs	CA 00 01 F6 03 qb d1 d2 cs
Set Heat Proportional Band (P=1-99.9)	CA 00 01 F1 02 d1 d2 cs	CA 00 01 F1 03 qb d1 d2 cs
Set Heat Integral (I = 0-9.99)	CA 00 01 F2 02 d1 d2 cs	CA 00 01 F2 03 qb d1 d2 cs
Set Heat Derivative (D= 0-5.0)	CA 00 01 F3 02 d1 d2 cs	CA 00 01 F3 03 qb d1 d2 cs
Set On/Off Array**	CA 00 01 81 02 d1 d2 cs	CA 00 01 81 01 d1 cs
Turn Off	CA 00 01 81 01 00 7C	CA 00 01 81 01 d1 cs
Turn On	CA 00 01 81 01 01 7B	CA 00 01 81 01 d1 cs
Is On or Off?	CA 00 01 81 01 02 7A	CA 00 01 81 01 d1 cs

* = limited to the range of the chiller

command bytes shown in **bold**

qb = qualifier byte, see Table 2

d1,d2 = 16 bit signed integer of the value being sent or received

cs = the checksum of the string (see text)

** d1: 0 = Off (unit)

1 = On

2 = No change

Table 2

QUALIFIER BYTE

00	0 precision, no units of measure
01	0 precision, °C
10	1 precision, no units of measure
11	1 precision, °C
20	2 precision, no units of measure

Example: The temperature of 45.6°C would be represented by the qualifier 11 hex, followed by the 2 bytes 01 C8 hex (456 decimal).

Table 3

REQUEST STATUS

BIT	d1	d2
b.7 = 1	0	Reserved
b.6 = 1	Reserved	Freeze Fault
b.5 = 1	Low Flow Warning	RTD1 Fault
b.4 = 1	Low Level Warning	0
b.3 = 1	High or Low Temp Warning	High Temp Fault
b.2 = 1	High or Low Temp Bypass	Low Temp Fault
b.1 = 1	Unit Faulted	Low Flow Fault
b.0 = 1	Unit Running	Low Level Fault

Appendix C RS-485 Serial Communications Protocol

NOTE: This appendix assumes you have a basic understanding of communications protocols.

All data is sent and received in binary form, do not use ASCII. In the following pages the binary data is represented in hexadecimal (hex) format.

The Neslab Serial Communications Protocol, NC, is based on a master-slave model. The master is a host computer, while the slave is the bath's controller. Only the master can initiate a communications transaction (half-duplex). The slave ends the transaction by responding to the master's query. The protocol uses an RS-485 serial interface with the default parameters: 9600 baud, 1 start bit, 8 data bits, 1 stop bit, no parity and a selectable address from 1 to 100.

NOTE: Before the unit will communicate, RS-485 must be turned on using the controller. Ensure the  indicator is illuminated.

The unit can be controlled through your computer's RS-485 serial port by using the unit's 9-pin RS-485 connection. Communication cables are available from Thermo NESLAB. Contact our sales department for additional information.

All commands must be entered in the exact format shown in the tables on the following pages. The Tables on the last page of this Appendix show all commands available, their format and responses. Controller responses are either the requested data or an error message. The controller response *must* be received before the host sends the next command.

The host sends a command embedded in a single communications packet, then waits for the controller's response. If the command is not understood or the checksums do not agree, the controller responds with an error command. Otherwise, the controller responds with the requested data. If the controller fails to respond within 1 second, the host should resend the command.

NC Serial Communications Protocol

NOTE: All byte values are shown in hex, hex represents the binary values that must be sent to the bath. **Do not use ASCII.**

The framing of the communications packet in both directions is:

Checksum region								
Lead char CC	Addr-MSB	Addr-LSB	Command	n d-bytes	d-byte 1	...	d-byte n	Checksum

<i>Lead char</i>	CC (hex).
<i>Addr-msb</i>	Most significant byte of device address is 00 hex.
<i>Addr-lsb</i>	Least significant byte of device address in hex (01 to 63 hex).
<i>Command</i>	Command byte (see Table 1).
<i>n d-bytes</i>	Number of data bytes to follow (00 to 03 hex).
<i>d-byte 1</i>	1 st data byte (the qualifier byte is considered a data byte).
...	...
<i>d-byte n</i>	n th data byte.
<i>Checksum</i>	Bitwise inversion of the 1 byte sum of bytes beginning with the most significant address byte and ending with the byte preceding the checksum. (To perform a bitwise inversion, "exclusive OR" the one byte sum with FF hex.)

The master requests information by sending one of the Read Functions as shown in Table 1. Since no data is sent to the bath during a read request, the master uses 00 for the number of data bytes following the command byte.

The bath will respond to a Read Function by echoing the lead character, address, and command byte, followed by the requested data and checksum. When the bath sends data, a qualifier byte is sent first, followed by a two byte signed integer (16 bit, MSB sent first). The qualifier byte indicates the precision and units of measure for the requested data as detailed in Table 2.

Appendix C As an example, the master requests to read internal temperature unit address 01 by sending:

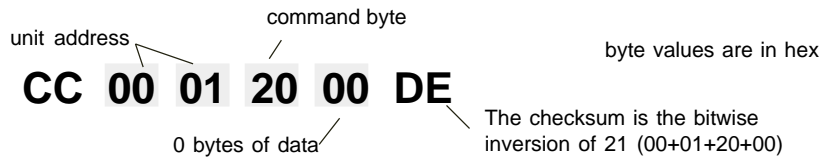

If the temperature is -10.5°C, slave #1 would reply:

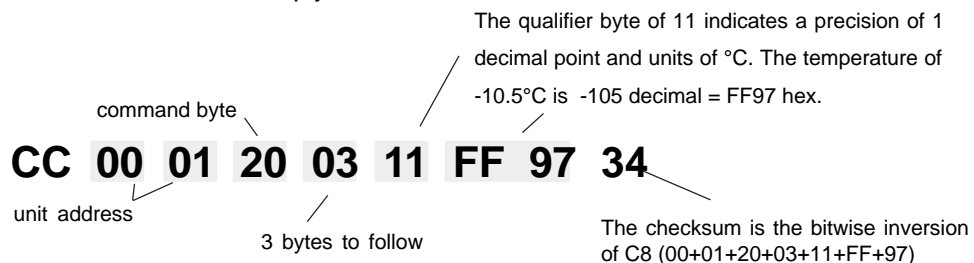

The master sets parameters in the bath by sending one of the Set Functions as shown in Table 1. The master does not send a qualifier byte in the data field. The master should be preprogrammed to send the correct precision and units (it could also read the parameter of interest first to decode the correct precision and units needed).

For example, if the master wants to set the setpoint to 30°C for unit #3, it would send :

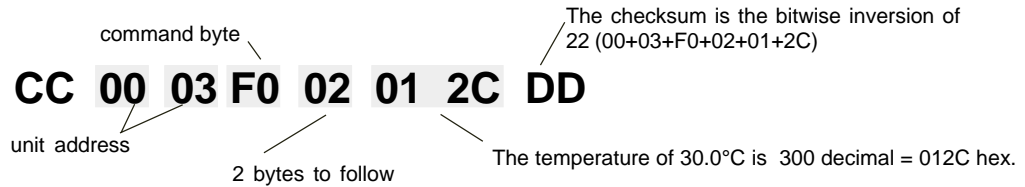

Slave #3 responds:

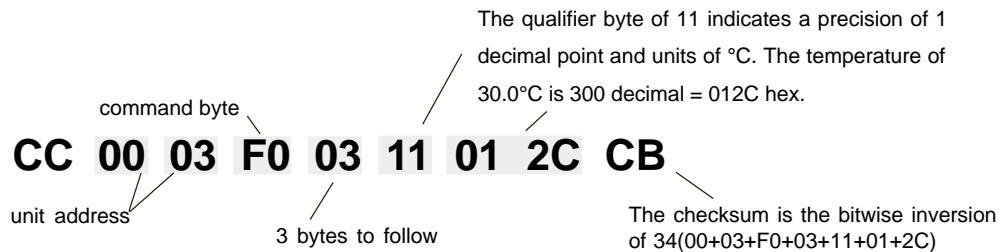

Table 1 Commands (All bytes are in hex)

FUNCTION	MASTER SENDS	UNIT RESPONDS
<u>READ</u>		
Read Acknowledge	CC 00 01 00 00 FE	CC 00 01 00 02 v1 v2 cs
Read Status*	CC 00 01 09 00 F5	CC 00 01 09 02 d1 d2 cs
Error		CC 00 01 0F 02 en ed cs
Read Internal Temperature	CC 00 01 20 00 DE	CC 00 01 20 03 qb d1 d2 cs
Read Setpoint (control point)	CC 00 01 70 00 8E	CC 00 01 70 03 qb d1 d2 cs
Read Low Temperature Limit	CC 00 01 40 00 BE	CC 00 01 40 03 qb d1 d2 cs
Read High Temperature Limit	CC 00 01 60 00 9E	CC 00 01 60 03 qb d1 d2 cs
Read Cool Proportional Band (P)	CC 00 01 74 00 8A	CC 00 01 74 03 qb d1 d2 cs
Read Cool Integral (I)	CC 00 01 75 00 89	CC 00 01 75 03 qb d1 d2 cs
Read Cool Derivative (D)	CC 00 01 76 00 88	CC 00 01 76 03 qb d1 d2 cs
Read Heat Proportional Band (P)	CC 00 01 71 00 8D	CC 00 01 71 03 qb d1 d2 cs
Read Heat Integral (I)	CC 00 01 72 00 8C	CC 00 01 72 03 qb d1 d2 cs
Read Heat Derivative (D)	CC 00 01 73 00 8B	CC 00 01 73 03 qb d1 d2 cs

command bytes shown in **bold**

qb = qualifier byte, see Table 2

d1,d2 = 16 bit signed integer of the value being sent or received

Bad data, 03: Bad checksum

cs = the checksum of the string (see text)

* See Read Status, see Table 3

v = protocol version

ed = error data

en = error number 01: Bad command, 02:

xx = no valid data, include in checksum

Table 1 Commands (continued) (All bytes are in hex)

FUNCTION	MASTER SENDS	UNIT RESPONDS
SET		
Set Setpoint (control point)*	CC 00 01 F0 02 d1 d2 cs	CC 00 01 F0 03 qb d1 d2 cs
Set Low Temp	CC 00 01 C0 02 d1 d2 cs	CC 00 01 C0 03 qb d1 d2 cs
Set High Temp	CC 00 01 E0 02 d1 d2 cs	CC 00 01 E0 03 qb d1 d2 cs
Set Cool Proportional Band (P=1-99.9)	CC 00 01 F4 02 d1 d2 cs	CC 00 01 F4 03 qb d1 d2 cs
Set Cool Integral (I = 0-9.99)	CC 00 01 F5 02 d1 d2 cs	CC 00 01 F5 03 qb d1 d2 cs
Set Cool Derivative (D= 0-5.0)	CC 00 01 F6 02 d1 d2 cs	CC 00 01 F6 03 qb d1 d2 cs
Set Heat Proportional Band (P=1-99.9)	CC 00 01 F1 02 d1 d2 cs	CC 00 01 F1 03 qb d1 d2 cs
Set Heat Integral (I = 0-9.99)	CC 00 01 F2 02 d1 d2 cs	CC 00 01 F2 03 qb d1 d2 cs
Set Heat Derivative (D= 0-5.0)	CC 00 01 F3 02 d1 d2 cs	CC 00 01 F3 03 qb d1 d2 cs
Set On/Off Array**	CC 00 01 81 02 d1 d2 cs	CC 00 01 81 01 d1 cs
Turn Off	CC 00 01 81 01 00 7C	CC 00 01 81 01 d1 cs
Turn On	CC 00 01 81 01 01 7B	CC 00 01 81 01 d1 cs
Is On or Off?	CC 00 01 81 01 02 7A	CC 00 01 81 01 d1 cs

* = limited to the range of the chiller

command bytes shown in **bold**

qb = qualifier byte, see Table 2

d1,d2 = 16 bit signed integer of the value being sent or received

cs = the checksum of the string (see text)

** d1: 0 = Off (unit)

1 = On

2 = No change

Table 2

QUALIFIER BYTE

00	0 precision, no units of measure
01	0 precision, °C
10	1 precision, no units of measure
11	1 precision, °C
20	2 precision, no units of measure

Example: The temperature of 45.6°C would be represented by the qualifier 11 hex, followed by the 2 bytes 01 C8 hex (456 decimal).

Table 3

REQUEST STATUS

BIT	d1	d2
b.7 = 1	0	Reserved
b.6 = 1	Reserved	Freeze Fault
b.5 = 1	Low Flow Warning	RTD1 Fault
b.4 = 1	Low Level Warning	0
b.3 = 1	High or Low Temp Warning	High Temp Fault
b.2 = 1	High or Low Temp Bypass	Low Temp Fault
b.1 = 1	Unit Faulted	Low Flow Fault
b.0 = 1	Unit Running	Low Level Fault

WARRANTY

ThermoNESLAB Instruments, Inc. warrants for 12 months from date of shipment any ThermoNESLAB unit according to the following terms.

Any part of the unit manufactured or supplied by ThermoNESLAB and found in the reasonable judgment of ThermoNESLAB to be defective in material or workmanship will be repaired at an authorized ThermoNESLAB Repair Depot without charge for parts or labor. The unit, including any defective part must be returned to an authorized ThermoNESLAB Repair Depot within the warranty period. The expense of returning the unit to the authorized ThermoNESLAB Repair Depot for warranty service will be paid for by the buyer. ThermoNESLAB's responsibility in respect to warranty claims is limited to performing the required repairs or replacements, and no claim of breach of warranty shall be cause for cancellation or rescision of the contract of sales of any unit. With respect to units that qualify for field service repairs, ThermoNESLAB's responsibility is limited to the component parts necessary for the repair and the labor that is required on site to perform the repair. Any travel labor or mileage charges are the financial responsibility of the buyer.

The buyer shall be responsible for any evaluation or warranty service call (including labor charges) if no defects are found with the ThermoNESLAB product.

This warranty does not cover any unit that has been subject to misuse, neglect, or accident. This warranty does not apply to any damage to the unit that is the result of improper installation or maintenance, or to any unit that has been operated or maintained in any way contrary to the operating or maintenance instructions specified in ThermoNESLAB's Instruction and Operation Manual. This warranty does not cover any unit that has been altered or modified so as to change its intended use.

In addition, this warranty does not extend to repairs made by the use of parts, accessories, or fluids which are either incompatible with the unit or adversely affect its operation, performance, or durability.

ThermoNESLAB reserves the right to change or improve the design of any unit without assuming any obligation to modify any unit previously manufactured.

THE FOREGOING EXPRESS WARRANTY IS IN LIEU OF ALL OTHER WARRANTIES, EXPRESSED OR IMPLIED, INCLUDING BUT NOT LIMITED TO WARRANTIES OR MERCHANTABILITY AND FITNESS FOR A PARTICULAR PURPOSE.

ThermoNESLAB'S OBLIGATION UNDER THIS WARRANTY IS STRICTLY AND EXCLUSIVELY LIMITED TO THE REPAIR OR REPLACEMENT OF DEFECTIVE COMPONENT PARTS AND ThermoNESLAB DOES NOT ASSUME OR AUTHORIZE ANYONE TO ASSUME FOR IT ANY OTHER OBLIGATION.

ThermoNESLAB ASSUMES NO RESPONSIBILITY FOR INCIDENTAL, CONSEQUENTIAL, OR OTHER DAMAGES INCLUDING, BUT NOT LIMITED TO LOSS OR DAMAGE TO PROPERTY, LOSS OF PROFITS OR REVENUE, LOSS OF THE UNIT, LOSS OF TIME, OR INCONVENIENCE.

This warranty applies to units sold in the United States. Any units sold elsewhere are warranted by the affiliated marketing company of ThermoNESLAB Instruments, Inc. This warranty and all matters arising pursuant to it shall be governed by the law of the State of New Hampshire, United States. All legal actions brought in relation hereto shall be filed in the appropriate state or federal courts in New Hampshire, unless waived by ThermoNESLAB.